

BS 5250:2011



BSI Standards Publication

Code of practice for control of condensation in buildings

NO COPYING WITHOUT BSI PERMISSION EXCEPT AS PERMITTED BY COPYRIGHT LAW

raising standards worldwide™



Publishing and copyright information

The BSI copyright notice displayed in this document indicates when the document was last issued.

© BSI 2011

ISBN 978 0 580 60471

ICS 91.120.99

The following BSI references relate to the work on this standard:

Committee reference B/540/2

Draft for comment 11/30171810 DC

Publication history

First published October 1975

Second edition June 1989

Third edition November 2002

Fourth edition December 2011

Amendments issued since publication

Date	Text affected
------	---------------

Contents

Foreword *iii*

1	Scope	1
2	Normative references	1
3	Terms and definitions	2
4	Design to avoid moisture related problems	4
5	Guidance to builders and owners	11
6	Remedial works	12

Annexes

Annex A (informative)	Moisture in buildings	13
Annex B (informative)	Diagnosis of dampness problems	16
Annex C (informative)	The temperature and moisture content of air	20
Annex D (normative)	Calculating condensation risk	23
Annex E (informative)	Properties of materials	31
Annex F (normative)	Application of design principles – Floors	38
Annex G (normative)	Application of design principles – Walls	43
Annex H (normative)	Application of design principles – Roofs	57
Annex J (informative)	Application of design principles at junctions	76
Annex K (informative)	Application of design principles – Occupied space ventilation	78
Annex L (normative)	Application of design principles – Heating	83
Annex M (informative)	Guidance for builders	85
Annex N (informative)	Guidance for occupiers on how to avoid damaging condensation	87

Bibliography 89

List of figures

Figure C.1	– Psychrometric chart showing the derivation of relative humidity from temperature and vapour pressure	21
Figure D.1	– Variation of internal humidity classes with external temperature	30
Figure F.1	– Groundbearing floor with insulation beneath the floor slab	40
Figure F.2	– Groundbearing floor with insulation above the floor slab	40
Figure F.3	– Suspended concrete floor with insulation above the floor slab	41
Figure F.4	– Suspended concrete floor with insulation below the floor slab	41
Figure F.5	– Suspended timber floor with insulation above the joists	42
Figure F.6	– Suspended timber floor with insulation between the joists	42
Figure F.7	– Timber suspended floor with a soffit of high vapour resistance	42
Figure G.1	– Solid masonry wall – External insulation and protective finish with low vapour resistance	45
Figure G.2	– Solid masonry wall – External insulation with high vapour resistance	45
Figure G.3	– Solid masonry wall – Internal insulation	46
Figure G.4	– Masonry wall with cavity – External insulation	47
Figure G.5	– Masonry wall with cavity – Insulation partially filling the cavity	48
Figure G.6	– Masonry wall with cavity – Insulation filling the cavity	48
Figure G.7	– Masonry wall with cavity – Internal insulation	49
Figure G.8	– Masonry wall – Concrete with insulating formwork	49
Figure G.9	– Framed wall – External insulation	51
Figure G.10	– Framed wall – Insulation between framing members	51
Figure G.11	– Framed wall – Internal insulation	52
Figure G.12	– Framed wall – External sheathing – Thermal insulation between the framing and on the outside of the sheathing	53
Figure G.13	– Framed wall – External sheathing – Thermal insulation between on the inside of the framing	54
Figure G.14	– Framed wall – Internal sheathing – Thermal insulation between and to the inside of the structural framing	54

Figure G.15 – Cladding systems – Integral thermal insulation – Prefabricated	55
Figure G.16 – Cladding systems – Integral thermal insulation – Built in situ	56
Figure G.17 – Structural insulated panel	57
Figure H.1 – Roofs categorized by position of the insulation	60
Figure H.2 – Cold pitched roof – LR underlay – Permeable external covering	65
Figure H.3 – Cold pitched roof – LR underlay – Impermeable external covering	66
Figure H.4 – Warm pitched roof with HR underlay – Any roof covering	68
Figure H.5 – Warm pitched roof with LR underlay and permeable roof covering	69
Figure H.6 – Warm pitched roof with LR underlay and impermeable roof covering	69
Figure H.7 – Routing insulation and AVCL in a hybrid pitched roof to achieve continuity	70
Figure H.8 – Cold flat roof – Framed structure	71
Figure H.9 – Cold flat roof – Dense structure	71
Figure H.10 – Warm flat roof – Framed structure	72
Figure H.11 – Warm flat roof – Dense structure	72
Figure H.12 – Inverted flat roof – Framed structure	73
Figure H.13 – Inverted flat roof – Dense construction	73
Figure H.14 – Site assembled metal roof	74
Figure H.15 – Composite panel roof	74
Figure J.1 – Temperature contours and heat flow lines at a corner on a masonry wall with insulated cavity	76
Figure J.2 – Temperature contours and heat flow lines through a concrete lintel in a masonry wall with insulated cavity	77

List of tables

Table A.1 – Effect of condensate on impermeable surfaces	15
Table D.1 – Monthly mean temperature and relative humidity for interstitial condensation calculations	25
Table D.2 – Corrections to monthly mean temperatures and relative humidities to create condensation risk years with various return periods	26
Table D.3 – Example of the calculation of estimated ground temperatures	27
Table D.4 – Moisture production rates in housing	28
Table D.5 – Typical moisture production rates from fuels	28
Table D.6 – Typical moisture generation rates for household activities	29
Table D.7 – Internal humidity classes: building types and limiting relative humidities at $T_3 = 0\text{ }^{\circ}\text{C}$	30
Table E.1 – Thermal conductivity and vapour resistivity of building materials	32
Table E.2 – Vapour resistances of thin membranes and foils	35
Table E.3 – Thermal resistance, in $\text{m}^2\text{K/W}$, unventilated cavities 5 mm and 25 mm wide with high emissivity surfaces	36
Table E.4 – Thermal resistance of roof spaces	37
Table E.5 – Thermal resistances of surfaces	37
Table E.6 – Factors for converting permeance units to $\mu\text{g/N}\cdot\text{s}$	38
Table H.1 – Minimum low level loft space ventilation openings	67

Summary of pages

This document comprises a front cover, an inside front cover, pages i to iv, pages 1 to 92, an inside back cover and a back cover.

Foreword

Publishing information

This British Standard is published by BSI and came into effect on 31 December 2011. It was prepared by Subcommittee B/540/2, *Building performance – Energy*, under the authority of Technical Committee B/540, *Energy performance of materials, components and buildings*. A list of organizations represented on this committee can be obtained on request to its secretary.

Supersession

This British Standard supersedes BS 5250:2002+A1:2005, which is withdrawn.

Information about this document

This is a full revision of the standard, and includes a complete re-structuring intended to make the standard more usable.

Moisture in buildings arises from several sources: if not properly controlled it can lead to mould growth and condensation – problems which affect about 15% of homes in England to some degree [1].

The requirement for more efficient use of energy in the operation and use of buildings has led to increased levels of thermal insulation and airtightness in both new and refurbished buildings; this has led to an increased risk of damage from condensation.

The occurrence of condensation is governed by complex interrelationships between heat, moisture, air movement, building layout and the physical properties of building materials. The designer's choice of plan form, envelope materials, construction details and systems of heating and ventilating can ensure the risk of damaging condensation is minimized under reasonable conditions of use. The builder's understanding of the design intent, together with good workmanship under proper supervision, can then result in a healthy environment within a durable building envelope.

Bearing in mind that occupants often fail to use buildings in the manner intended, be it by choice, lack of understanding or force of circumstance, designers are advised to err on the side of caution and adopt robust fail-safe solutions.

When it is proposed to re-furbish a building or make changes to its use, the risk of condensation has to be re-assessed in the light of the new usage.

Use of this document

As a code of practice, this British Standard takes the form of guidance and recommendations. It should not be quoted as if it were a specification and particular care should be taken to ensure that claims of compliance are not misleading.

Any user claiming compliance with this British Standard is expected to be able to justify any course of action that deviates from its recommendations.

Presentational conventions

The provisions in this standard are presented in roman (i.e. upright) type. Its recommendations are expressed in sentences in which the principal auxiliary verb is "should".

Commentary, explanation and general informative material is presented in smaller italic type, and does not constitute a normative element.

Contractual and legal considerations

This publication does not purport to include all the necessary provisions of a contract. Users are responsible for its correct application.

Compliance with a British Standard cannot confer immunity from legal obligations.

1 Scope

This British Standard gives recommendations and guidance on avoiding problems with high moisture levels and condensation in buildings. Recommendations given are based on forms of construction commonly adopted in the UK.

This British Standard gives guidance on the risks associated with excessive humidity in buildings, notably mould growth and condensation, which can endanger the health and well-being of building occupants and the integrity of the building fabric. It describes the principal sources of water vapour, its transportation and deposition and provides guidance on how to manage those risks during the design, construction and operation of buildings.

The guidance contained in this standard is relevant to buildings of all types, whatever their form, construction and occupancy. However, this standard does not cover buildings used for storage at sub-zero temperatures.

Recommendations and guidance on how to avoid penetration of the building envelope by water is contained in other British Standards, for example BS 8103-1, BS 8103-3 and BS 8103-4 for floors, BS 8103-2 and BS 8104 for walls, BS 5534 for pitched roofs and BS 6229 for flat roofs.

Essential design data are contained in the annexes to this standard, including:

- the essential relationship between temperature and moisture content of air;
- methods of calculating the risk of surface and interstitial condensation;
- typical quantities of moisture generated in buildings of various uses and levels of occupation;
- thermal conductivity and vapour resistivity values of common building materials;
- factors for the conversion of common units.

2 Normative references

BS 3533, *Glossary of thermal insulation terms*

BS 5534, *Code of practice for slating and tiling (including shingles)*

BS 5720, *Code of practice for mechanical ventilation and air conditioning in buildings*

BS 5925, *Code of practice for ventilation*

BS 6229, *Flat roofs with continuously supported coverings – Code of practice*

BS 8104, *Code of practice for assessing exposure of walls to wind-driven rain*

BS 8297, *Code of practice for Design and installation of non-loadbearing precast concrete cladding*

BS 8298, *Code of practice for design and installation of natural stone cladding and lining*

BS 9250, *Code of practice for the design of the airtightness of ceilings in pitched roofs*

BS EN 490, *Concrete roofing tiles and fittings for roof covering and wall cladding – Product specifications*

BS EN 1279 (all parts), *Glass in building – Insulating glass units*

BS EN 14783, *Fully supported metal sheet and strip for roofing, external cladding and internal lining – Product specification and requirements*

BS EN ISO 6946:2007, *Building components and building elements – Thermal resistance and thermal transmittance – Calculation method*

BS EN ISO 10211, *Thermal bridges in building construction – Heat flows and surface temperatures – Detailed calculations*

BS EN ISO 13788, *Hygrothermal performance of building components and building elements – Internal surface temperature to avoid critical surface humidity and interstitial condensation – Calculation methods*

BS EN ISO 13789, *Thermal performance of buildings – Transmission and ventilation heat transfer coefficients – Calculation method*

3 Terms and definitions

For the purposes of this British Standard, the terms and definitions given in BS 3533 and the following apply.

3.1 air and vapour control layer

AVCL

continuous layer of impermeable material

3.2 breather membrane

membrane with water vapour resistance greater than 0.25 MN·s/g and less than 0.6 MN·s/g

3.3 condensate

liquid water produced by condensation

3.4 condensation

conversion of water vapour to liquid water

3.5 conditioned space

occupied space in which the temperature and humidity are controlled

3.6 damp proof membrane

membrane which is intended to resist the passage of moisture from the ground to a floor

NOTE It will also constitute an AVCL.

3.7 dewpoint

temperature at which air becomes saturated with water vapour

3.8 dry bulb temperature

temperature of the air as measured by a dry thermometer

3.9 emissivity

ratio of radiant energy emitted by a surface to that emitted by a black body at a given temperature

3.10 evaporation

conversion of liquid water to water vapour

3.11 humid

quality of air or weather being moist or damp

3.12 humidity

moisture content of air

- 3.13 hygroscopic**
readily taking up water vapour from the air
- 3.14 hygrothermal**
pertaining to the simultaneous movement of moisture and heat
- 3.15 interstitial condensation**
condensation which occurs within or between layers of a construction
- 3.16 membrane**
thin layer of material
- NOTE The resistance of a membrane to the passage of air and water vapour is dependent on its composition and has to be specified according to the required performance in each application.*
- 3.17 moisture**
water in solid, liquid or gaseous phase
- 3.18 relative humidity**
amount of water vapour contained within a given volume compared with the maximum amount at the given temperature (usually expressed as %rh)
- 3.19 saturation vapour pressure**
maximum vapour pressure over a plane water surface, at any given temperature
- 3.20 stack effect**
tendency of air in a building to rise as a result of differential temperatures and air density
- 3.21 surface condensation**
condensation which occurs on a visible surface within a building
- 3.22 thermal bridge**
part of a construction with thermal resistance significantly lower than that of the surrounding construction
- 3.23 underlay, HR**
membrane with water vapour resistance greater than 0.25 MN•s/g
- 3.24 underlay, LR**
membrane with water vapour resistance not exceeding 0.25 MN•s/g
- 3.25 vapour**
substance in its gaseous phase
- 3.26 vapour diffusivity**
rate of diffusion through unit thickness of material at unit water vapour pressure difference
- 3.27 vapour pressure**
that part of atmospheric pressure which is due to the presence of water vapour
- NOTE Expressed in kPa (1 kPa = 10 millibars = 1000 N/m²)*
- 3.28 vapour resistance**
resistance of a material to the diffusion of water vapour
- NOTE Expressed in MN•s/g*

- 3.29 vapour resistivity**
resistance of unit thickness of material to the diffusion of water vapour at unit vapour pressure difference
NOTE Expressed in MN·slg·m
- 3.30 vent**
opening provided for the passage of air
- 3.31 vented cavity**
volume of air with openings to the outside air so placed as to allow some limited, but not necessarily through, movement of air
- 3.32 ventilate**
expose to a current of fresh air
- 3.33 ventilated cavity**
volume of air with openings to the outside air so placed as to promote the through passage of air
- 3.34 ventilated void**
large volume of air with openings to the outside air so placed as to promote the through passage of air
- 3.35 ventilation**
- circulation of air
 - systems or means of providing fresh air
- 3.36 water vapour**
water in its gaseous phase
- 3.37 well-sealed ceiling**
ceiling incorporating seals which prevent the transfer of warm, moist air into the loft or roof space in accordance with the recommendations of BS 9250
- 3.38 wet bulb temperature**
temperature of the air as measured by a thermometer cooled by evaporation of water

4 Design to avoid moisture related problems

4.1 General

In order to avoid the occurrence of excess condensation, which can result in mould growth and damage to building fabric and/or contents, designers should assess the amount of water vapour likely to be generated within the building and determine the resultant increase in internal vapour pressure above that of external air. They should then give careful consideration to the physical properties of the construction separating inside from outside.

Designers should consider the effects of the external climate, which, being site related, is beyond direct control but may be moderated by the building's form and orientation in relation to topography, prevailing winds, sunlight and over-shadowing.

Designers should also bear in mind that the rate at which humidity is generated can change over time as buildings are adapted to different functions or levels of occupancy; furthermore, the cost of energy might well deter occupants from maintaining an adequate heating regime.

COMMENTARY ON 4.1

Once moisture from the construction phase has been removed, the rate at which humidity is generated within a building is determined by the occupants and their activities: swimming pools, some industrial processes, laundries, canteens and food factories, for example, generate very large amounts of moisture.

In order to avoid surface condensation the appropriate relationship between internal vapour pressure and the temperature of internal surfaces has to be achieved. In buildings with high internal humidity all surfaces have to be kept at a higher temperature than those in buildings with low internal humidity; they therefore require a higher level of insulation or greater use of energy, be it for heating or for the removal of excess moisture.

4.2 Assessing the likelihood of condensation

4.2.1 General

Designers should assess the risk of surface condensation, mould growth and interstitial condensation using the methods described in BS EN ISO 13788, which determines three criteria for assessment.

- 1) The design of the structure and the heating system should ensure that, over the coldest month, the average relative humidity at internal surfaces does not exceed 80%, the limit for mould growth (but see also 4.5.2).
- 2) Any interstitial condensation which might occur in winter should evaporate during the following summer, preventing an accumulation of moisture year on year.
- 3) The risk of degradation of materials should be assessed in terms of the maximum level of condensate which might occur.

NOTE 1 Software programs are available to perform the calculations.

If an assessment indicates condensation is likely to occur, then the designer should assess the likelihood of it causing damage to the materials used and if necessary modify the design. Organic materials should not be exposed to harmful and prolonged condensation.

In flat roofs with a continuously supported waterproof covering the maximum predicted amount of condensate should not exceed 350 g/m² and any condensate should dry out during the course of the year so as to avoid year on year accumulation.

Designers should be aware that BS EN ISO 13788 considers only the risks arising from the diffusion of water vapour through the building fabric; it does not take account of the much greater risk of condensation occurring as a result of air leakage, which transports water vapour through gaps, joints and cracks in the building fabric.

Whilst external climate data from an average year should be appropriate for the calculation of long-term energy demand, its use for condensation risk analysis might not be appropriate since years worse than average will occur and might result in damaging condensation. For most buildings, a once-in-ten-year climate year will be appropriate. For particularly sensitive constructions or buildings with vulnerable contents, a once-in-twenty or once-in-fifty-year climate year may be considered more appropriate.

NOTE 2 Guidance is given on the selection of more severe years in D.3.2.

4.2.2 Cold pitched roofs

Condensation on the coldest plane, usually on the underlay, should be removed by ventilation to outside air, assisted by wind action. The rate of ventilation is based on empirical experience. For building uses which generate moisture conditions not greater than those in domestic houses, see 4.5.2.

Where ventilation paths are restricted or obstructed or where the building occupation generates moisture greater than that covered by empirical experience, cold roofs should not be adopted.

The methods of assessing condensation risk described in BS EN 13788 do not apply to cold roofs.

4.3 Internal climate

4.3.1 General

The appropriate operational conditions of a building should first be determined by reference to user requirements and then maintained by controlling the internal temperature, relative humidity and air movement.

NOTE 1 Human comfort conditions lie in the range of 45%rh to 60%rh at 18 °C to 24 °C.

The internal climate of a building should be controlled in order to ensure the health, well-being and comfort of its occupants and the proper functioning of equipment such as boilers, fires and cookers. Air which is contaminated by combustion products, bacteria, mould, smoke, smells, high levels of CO₂, excess water vapour and heat should be removed and replaced by fresh air. The temperature and distribution of that incoming fresh air should be considered in order to avoid it being perceived as an unwanted draught.

NOTE 2 Such an exchange of air removes not only the contaminants but also heat, which can be beneficial in summer, but undesirable in winter.

If, at the designed operational temperature, relative humidity is likely to exceed 70% (see A.5) it will be necessary to extract water vapour from the air; that may be achieved by ventilation or by dehumidification.

NOTE 3 Historically, sufficient fresh air for the building occupants and their activities was available as a result of air leakage through the gaps, cracks and openings in the building envelope, such unintentional air movement is no longer acceptable in buildings which require a heated interior because it is wasteful of energy. The ventilation rate to avoid excessive humidity in a dwelling will normally provide sufficient fresh air for healthy indoor conditions.

4.3.2 Ventilation

Designers should ensure the external envelope of the building is as airtight as practicably possible and then make provision for the required level of ventilation. Ventilation systems should be designed to extract moist air as close as possible to the point of generation and to discharge it to the outside, preferably away from the prevailing wind.

Designers may specify natural or mechanical ventilation systems which may rely on the uncontained movement of air from one space to another or on ducts to transport air.

Natural systems allow air to move through a building in response to pressure differential across the building envelope, which is generated by internal/external temperature differences, together with wind forces; such systems use no electrical energy. The recommendations in BS 5925 should be followed when designing natural ventilation systems, including passive stack systems.

Mechanical systems may be designed to extract air from a building, allowing replacement air to be drawn in through vents, or they may be designed to force external air into the building, allowing stale air to pass out through vents. Alternatively, the system may be designed to move balanced volumes of air in and out of the building. All mechanical systems rely upon the use of electrical energy; the recommendations in BS 5720 should be followed when designing a mechanical ventilation system.

Any ventilation system requires the provision of vents, which may be manually controlled or regulated by thermostatic or hygrostatic means.

Where a domestic heated drying cupboard is provided it should be ventilated to discharge moisture directly to outside air, but where that is not practicable it may be vented to a room which is provided with an extractor fan controlled by a humidistat.

NOTE Detailed guidance on ventilation can be found in Annex K.

4.3.3 Dehumidification

The process of mechanical dehumidification may be beneficial in the short term, for example to remove entrapped construction moisture or moisture introduced by flooding or broken pipework, but it cannot remove contaminants such as CO₂ and smells.

COMMENTARY ON 4.3.3

Electrically powered dehumidification units, running on a closed cycle, draw air from a given space, heat and dry it, and then return it to the same space, the moisture being discharged to drain. Dehumidification units are more effective where excess moisture is caused by high vapour pressure in well heated buildings; they are less effective at low temperature.

4.3.4 Heating

Heating should maintain air and surface temperatures sufficient to prevent problems associated with excessive humidity. To be effective, the heating regime should be matched to the construction as described in 4.5.2.

COMMENTARY ON 4.3.4

Less heat is required to prevent moisture related problems in a building which is well-designed and well-insulated: a well-insulated building is more energy efficient, more economical to run and, when not heated as intended, less prone to condensation. If the heating system maintains comfort conditions in the whole building at all times, condensation problems are minimized, but costs are relatively high. If all or part of a building is used and heated infrequently the construction remains cold, increasing the risk of severe condensation: that risk is greatest if the construction has high thermal mass and heating is purely convective. If some rooms are unheated then water vapour which moves from other rooms can raise the relative humidity high enough to cause condensation or mould growth.

4.4 External climate

Designers should assess and document the factors likely to affect the formation and persistence of condensation in buildings, including exposure to sunlight, clear night skies, wind and driving rain, the potential effects of which are as follows.

- a) *Solar gain.* The external surface temperature of roofs and walls can be increased several degrees above the external air temperature, even in winter, by direct sunlight. This can promote rapid drying of any condensation which has occurred within the structure, it can also drive moisture towards the interior of the building where it might condense on any AVCL. The degree of exposure to direct sunlight can be affected by neighbouring buildings and/or trees.
- b) *Night sky radiation.* On clear nights at any time of year the radiative temperature of the sky is much less than the external air temperature; the external surface of roofs cool rapidly overnight, which means interstitial condensation can occur on the underside of an external weatherproof layer. Although this might evaporate rapidly the next day, there can be sufficient accumulation of condensate to cause running or dripping overnight.

- c) *Exposed positions.* High wind speeds, especially when accompanied by precipitation, chill the external surface of the building, thereby significantly increasing the risk of interstitial condensation within the structure.

4.5 The external envelope

4.5.1 General

All elements of building construction should meet their functional requirements, which include the avoidance of damaging surface and interstitial condensation. The choice of materials used to form the external envelope of a building should be determined by considerations of appearance, construction requirements and cost. When selecting and positioning materials within an element, designers should consider the performance characteristics of those materials in relation to heat, air and water vapour.

COMMENTARY ON 4.5.1

In the UK climate the essential functional requirement of the external envelope is to provide protection to the occupants by excluding rain and wind whilst moderating the flow of heat.

Most elements of construction (floors, walls and roofs) consist of several layers, each chosen to perform specific functions, be it external appearance, loadbearing, fire protection, airtightness, energy conservation, sound attenuation or internal appearance: some materials have a single function, others might perform several functions. The rate at which heat, air and moisture are transferred through the building envelope and the risk of interstitial condensation are determined by the properties of the various layers of construction and their position relative one to another.

The risk of condensation occurring at any point in a construction is determined by the differences between the internal and external temperature and vapour pressure, the materials which make up the building envelope (including any cavities) and the relative positions of those materials.

Lightweight constructions (those with low thermal mass inside the insulated envelope) have a rapid thermal response rate; they heat up and cool down quickly. Massive constructions (those with high thermal mass inside the insulated envelope) have a slow thermal response rate; they heat up and cool down slowly.

Depending upon their nature, the durability and performance of all building materials are adversely affected by moisture to some degree; notably, the rate of heat flow through any material is greater in the presence of moisture. Hygroscopic materials such as plaster, masonry and timber will absorb moisture, but might release it without suffering structural damage: non-hygroscopic materials such as metals, glass and plastics are impervious but might suffer damage from prolonged exposure to moisture.

Heat is transferred through materials and constructions by conduction, by convection and by radiation. Water vapour is transferred through materials by diffusion, but much more significant water vapour transfer occurs as a result of air movement; therefore, when designing to avoid the risk of damaging condensation, air filtration into and air leakage through the construction are the most important mechanisms to be considered. Consideration also has to be given to the fact that different materials offer different degrees of resistance to the various forms of transfer of both heat and moisture.

4.5.2 Arrangement of materials in constructions

In order to avoid interstitial condensation in any element, materials with the highest vapour resistance should be located on the warm side, and those with lower vapour resistance on the cold side, of any thermal insulation.

Constructions which incorporate an impervious external weathering layer (such as sheet metal or glass) contravene those basic recommendations: in such constructions provision should be made for ventilation behind/beneath the impervious layer to allow any moisture to disperse to atmosphere.

The position of thermal insulation in relation to the thermal mass of a building will determine whether or not that mass is warmed by the heating system; designers should consider the relative position of structural layers, thermal insulation layers and AVCLs in order to avoid damaging condensation.

In a building which is occupied and heated only intermittently, thermal insulation should be applied as close as possible to the internal surface and be protected by an AVCL. Designers should, however, bear in mind that in such constructions any layers outside the insulation will be isolated from the heating systems and therefore present a greater risk of interstitial condensation occurring. Conversely, in a building which is occupied and heated continuously any thermal insulation is best applied outside the thermal mass and should have low vapour resistance.

Designers should bear in mind that if the thermal mass is adjacent to the occupied space it will have a beneficial effect, tending to reduce fluctuations in internal temperature and minimizing the risk of surface condensation. However, a building with such a construction, which is occupied and heated only intermittently, is likely to experience low internal surface temperatures, leading to a greater risk of mould growth and of surface condensation.

With all forms of construction particular care should be taken to minimize the effects of thermal bridges at junctions between building elements (wall/floor, wall/wall, wall/roof) and those between building elements and components (wall/window, wall/door, roof/rooflight); at such junctions there is a higher rate of heat loss which results in lower surface temperatures and an increased risk of mould growth and surface condensation. See guidance in Annex J.

The air permeability of the external envelope should be as low as practically possible to minimize heat loss from the building by air leakage and to facilitate control of the internal climate. An airtight layer on the warm side of the envelope will minimize the penetration of warm moist air into the construction and so reduce the risk of interstitial condensation. Air movement from a heated building into a cold cavity will greatly increase the risk of condensation and should be avoided.

4.5.3 Cavities

Designers should recognize that most conventional forms of construction, including suspended floors, masonry walls and pitched roofs, contain cavities which are likely to have a significant effect on the risk of condensation occurring.

Air movement from within the building into any cavity should be avoided by the adoption of airtight construction.

COMMENTARY ON 4.5.3

Water vapour can be transferred across any cavity by air movement. Air movement from inside a heated building into a cold cavity will not only increase the rate of heat loss from the building, but also greatly increase the risk of interstitial condensation. Calculations suggest that even minimal air movement will have a significant effect on the risk of condensation occurring.

Air flows in lofts are well understood, but little is known about air movement rates in smaller cavities, such as those in masonry walls and flat roofs. Such cavities, particularly if vented only at one end, offer significant resistance to the through flow of air.

Even in sealed cavities, water vapour and heat are transferred by convection currents generated by temperature differences between the two surfaces of the cavity. Any surface facing a cavity will radiate heat across that cavity, the rate of transfer being dependent upon the emissivity of the surface: a low emissivity surface reduces the rate of heat transfer by radiation.

4.5.4 Thermal insulants

Thermal insulants should always be selected by matching their performance characteristics to the specific requirements of their application, with particular regard to their hygrothermal characteristics. Designers should bear in mind that different insulants offer different degrees of resistance to the transfer of both heat and moisture. When thermal insulation is provided in more than one layer, it is essential that their relative physical characteristics be carefully evaluated and the risk of interstitial condensation assessed.

Gaps in the thermal insulation and between that insulation and adjacent materials such as rafters, joists and studs, can give rise to localized condensation.

4.5.5 Low emissivity materials

When considering the use of low emissivity materials designers should carefully assess the risk of condensation occurring, using the method described in Annex D, with performance data which has preferably been evaluated and certified by an accredited third-party. In order to obtain the stated level of performance of any low emissivity material, it is essential that the material is installed facing a cavity; designers should pay particular attention to the practicability of forming and maintaining those conditions throughout the life of the building.

COMMENTARY ON 4.5.5

Low emissivity materials, such as aluminium foil or metalized plastics, have a highly reflective surface which can reduce the rate of heat transfer by radiation when installed facing a cavity: preferably one not less than 25 mm wide. The vapour resistance of such materials can be very high, as in the case of aluminium foil, or low, as in the case of metalized non-bonded polyolefin membranes.

In terms of transfer of heat, air and moisture the overall performance of low emissivity materials when installed in the building, will depend upon the treatment of laps and joints. When wrongly placed, or not properly sealed at joints, low emissivity materials can greatly increase the risk of interstitial condensation occurring.

4.5.6 Air and vapour control layers

For each element of construction (floors, walls and roofs) the designer should determine the vapour control plane upon which the movement of water vapour is to be controlled: it is essential those planes be continuous over the whole of the element and that they be joined to the vapour control planes of adjoining elements. Any AVCL should be located on the warm side of the insulation layers.

Impervious materials of construction, such as glass, metal or plastics sheet floor covering, may of themselves constitute all or part of a vapour control plane.

Depending upon the materials forming an element and their disposition in relation one to another, it might be necessary to provide a layer of material specifically to control the movement of water vapour; such a layer will constitute an AVCL, forming a barrier to both water vapour and air.

The selection of vapour control materials should be determined by:

- a) the degree of vapour resistance required (determined by assessing the likelihood of interstitial condensation using the method and guidance in Annex D and the vapour resistance values of various materials given in Annex E);
- b) the practicability of installation, including the formation of sealed laps and joints;
- c) the anticipated life to renewal.

An AVCL may consist of:

- 1) materials of construction with an inherently high vapour resistance such as glass, plastics sheet floor covering or steel liner in insulated twin skinned panel;
- 2) an applied surface coating;
- 3) an integral barrier, such as a board with an applied film or foil;
- 4) an impermeable membrane.

Designers should determine the performance standard required in any given situation and ensure the specified AVCL will meet that standard over the life of the building. It should be borne in mind that some membranes offer high resistance to the passage of water vapour and air, whilst others offer high resistance to air leakage but low resistance to the passage of water vapour.

In order to form an effective AVCL, side and end joints should be kept to a minimum, joints in flexible membranes should be formed over solid backing members or a rigid substrate, be lapped at least 50 mm and be sealed. Any damage should be repaired using matching material and jointing techniques. Unstabilized plastics-based sheeting should be protected from heat and sunlight to prevent degradation.

Penetrations through an AVCL by pipes and services will compromise its performance; they should preferably be eliminated at the design stage: if that is not possible they should be adequately sealed by means of proprietary seals and collars, or liquid-applied sealants, which should be able to accommodate thermal and other movements, likely to occur during the life of the building.

A void should be formed behind the internal surface finish to enable services to be installed without compromising the AVCL (see 4.2).

Building owners/occupants should be made aware of the importance of maintaining AVCLs throughout the life of the building, particularly when repairs, alterations and extensions are made.

4.6 Alterations and extensions to buildings

Where a building is to be altered or extended it is essential to determine what precautions to prevent condensation were included in the original building: those precautions should be retained, adapted and, if necessary, improved. The new work should follow the guidance set out in this standard. If the building is merely to be repaired, then a diagnosis of its existing condensation problems should be made and remedial action should be taken in accordance with Clause 6.

5 Guidance to builders and owners

5.1 Builders

Builders should be instructed to take appropriate steps to minimize the likelihood of damaging condensation, for example, by protecting the construction from precipitation.

NOTE Annex M contains draft guidance which may be modified for inclusion in sitework instructions.

5.2 Building owners and occupiers

Building owners and occupiers should be given information about the control of condensation so as to enable them to use the building within its design limit, and, by following some simple rules, to minimize the risk of condensation occurring.

NOTE Annex N contains suggested text for inclusion in an owner's manual.

6 Remedial works

6.1 Action to control condensation

Any action to control condensation should take account of the intended use of the building and involve comprehensive consideration of heating, ventilation and thermal insulation.

6.2 Heating

All surface condensation problems may, in principle, be solved by the application of heat to raise temperatures above the dewpoint, coupled with adequate levels of ventilation.

A common cause of harmful condensation in existing buildings is lack of adequate heating. If the existing system is inadequate, a heating system designed in accordance with the guidance given in Annex L should be installed.

Heating and insulation should always be considered together as the provision of adequate insulation ensures both capital and running costs are kept to a minimum.

6.3 Ventilation

In order to keep the internal relative humidity low enough to prevent a build-up of harmful condensation, it is essential that adequate ventilation be provided (see Annex K).

6.4 Insulation

NOTE Whilst adding insulation to the fabric of the building is likely to allow the interior to be heated adequately at reasonable cost, it will not, of itself, reduce the risk of condensation.

Any additional insulation should be located with regard to 4.5.4.

Annex A
(informative)**Moisture in buildings****A.1 General**

Excess moisture in a building can lead to condensation and mould growth which represent risks to the structural integrity of the building and the health of its occupants. In order to manage those risks the designer has to first recognize the relationship between heat, air and moisture, consider likely sources of moisture and the generation of water vapour, its transportation and deposition.

It is essential that moisture entrapment during construction and water vapour generation during occupation is minimized, and that excess moisture is removed as close to source as possible.

A.2 Sources of moisture

The sources of moisture in buildings are numerous and varied and include the following.

- a) *Water used in construction*: materials such as masonry, concrete and plaster require the addition of water for the purposes of hydration; surplus moisture will migrate to atmosphere. The design and construction processes have to facilitate the safe removal of such moisture.
- b) *Ground water*: groundbearing floors and walls in contact with the ground have to be capable of resisting all ground-borne moisture; this is normally achieved by using over-site waterproofing membranes and damp-proof courses. Constructions below ground have to be protected – three methods are recommended in BS 8102.
- c) *Flooding*: flood water can be absorbed into the fabric of a building, causing damage and creating a health hazard. In addition, as that water is released it can create an acute increase in the risk of condensation.
- d) *Precipitation*: rainwater is a primary source of moisture, the effects of which have to be considered both during construction and post completion. Construction work in progress has to be protected against precipitation which is likely to damage materials and increase the risk of subsequent condensation. The design and detailing of the external envelope, once completed, has to provide protection against precipitation, in particular against wind-driven rain, which can be absorbed into masonry, reducing the overall thermal resistance of walling. Careful attention has to be paid to joints and junctions in and between components and elements. Refer to BS 8104 for climate data; to BS 8204 (all parts) for floors; to BS 8104 for walls; to BS 6229 for flat roofs and to BS 5534 for pitched roofs.
- e) *Spillages and leaks*: damage or defects in the external envelope and defective joints or fractures in water or waste pipes will lead to damage to water-sensitive materials and finishes, and are likely to increase the risk of condensation. Prompt attention is required to remedy such damage and defects.
- f) *Flueless heating appliances*: supplementary space heating appliances, such as flueless gas fires or free-standing units burning LPG, produce large volumes of water vapour.
- g) *Air-borne moisture*: during spells of warm, humid weather the air entering the building from outside contains relatively high levels of moisture.
- h) *Building use*: once the building is occupied and in use, activities within the building, at different times, generate variable amounts of water vapour (see Annex D for details). The amount of water vapour is determined by the number of occupants and the activities they undertake. The water vapour which is generated (for example by breathing, washing, drying clothes,

cooking) results in an increase in internal vapour pressure. Some industrial processes including laundries, canteens, food factories and swimming pools generate very large amounts of water vapour.

The internal vapour pressure in a typical UK dwelling in winter will be some 1.0 kPa to 1.2 kPa, against an external vapour pressure of 0.5 kPa to 0.6 kPa. However, in an air-conditioned building, in a warm humid climate, then the internal vapour pressure might be lower than that outside.

The relative humidity of the ambient air determines the water content of hygroscopic materials; that moisture might later be released back to atmosphere as the relative humidity is lowered, but if the humidity level remains high it will increase the risk of surface mould growth, the corrosion of metals and the decay of timber-based products.

A.3 Transportation of water vapour

Water vapour is transported both by vapour pressure differences and by air movement.

Water vapour is transported both by air movement and by diffusion with the rate of transfer by air movement being much greater than that by diffusion. Wind acting upon a building produces, on the leeward side, a negative pressure zone which tends to draw air from the building through any gaps and openings in the envelope; higher internal temperatures in cold weather increase the air pressure at high level inside the building relative to the outside, also driving air through the structure; the amount of water vapour removed by such air movement will be governed by the size and disposition of gaps and openings.

Water vapour diffuses through most building materials, the rate of diffusion being dependent upon the difference in vapour pressure between inside and outside and the vapour resistance of each layer of material in the construction.

Wind acting on a building results in increased air pressure on the windward side and reduced air pressure on the leeward side; this tends to draw air through gaps and cracks in the construction: air is drawn out of the building on the leeward side, to be replaced by external air from the windward side. The rate by which air is transported by this inadvertent infiltration depends upon the number and dimensions of those gaps and cracks, together with the pressure created by a combination of wind forces and temperature-induced stack effect.

It is important to recognize that the rate at which water vapour is transported by air movement is much greater than the rate of transportation by diffusion.

As air within a building is heated it tends to rise: whilst this stack effect increases the risk of condensation and mould occurring at high level, it can be used to advantage by adopting a system of passive ventilation to remove excess moisture.

A.4 Hygroscopic materials

Most materials are hygroscopic (able to absorb and desorb water vapour). This can have a beneficial buffering effect, reducing the risk of both surface and interstitial condensation during rapid fluctuations of temperature and vapour pressure. However, hygroscopic materials exposed to high levels of humidity can, over time, absorb sufficient moisture to cause damage to elements of structure, to finishes, to furniture and to furnishings.

A.5 Mould

Large numbers of mould spores are always present in the atmosphere. In order to germinate those spores require warmth, a source of nutrition, oxygen and moisture; because they are hygroscopic they do not require liquid water. Many mould spores can germinate if the relative humidity at the surface exceeds 80%. Once established mould spores can continue to grow at a moisture level lower than 80%.

Buildings provide many sources of nutrition, and oxygen is always present, consequently the growth of moulds depends on moisture conditions at internal surfaces. In winter the internal surfaces of the external walls can be colder than the air in the room and the relative humidity at the face of the wall is about 10% greater than that in the room. As a result, if the relative humidity of the room stays at 70% for long periods of time the external wall surfaces will be sufficiently humid to support the growth of mould.

Mould presents a hazard to health; it is closely associated with respiratory allergies, especially asthma, in sensitive (atopic) individuals. Mould growth within a building can cause significant distress to the occupants even in the absence of any physical symptoms, it can damage the building fabric, surface finishes, fittings, clothing and furnishings, particularly those in unheated spaces such as lofts or parts of rooms sheltered from heating systems, such as cupboards or wardrobes placed against external walls.

A.6 Surface condensation

Warm humid air within buildings, if cooled to its dewpoint by contact with cold, non-absorbent surfaces, such as window glass, un-insulated pipework and cisterns, will deposit excess moisture on those surfaces as condensate. Whilst that condensate might not damage the material on which it occurs, if sufficient accumulates it will run or drip onto other materials where it might cause damage (see Table A.1).

Table A.1 Effect of condensate on impermeable surfaces

Amount of condensate g/m ²	Effect
< 30	A fine mist which does not run or drip
30 – 50	Droplets form and begin to run down vertical surfaces
51 – 250	Large drops form and begin to run down sloping surfaces: <ul style="list-style-type: none"> • 70 g/m² will run down a 45° slope • 150 g/m² will run down a 23° slope
> 250	Drops form and drip from horizontal surfaces

A.7 Interstitial condensation

Interstitial condensation occurs within a construction when water vapour moving through that construction comes into contact with a material which is at or below the dewpoint of the vapour. Such condensation is more likely to occur on the surfaces of materials but can occur within the body of a material if that is where dewpoint occurs. In a multi-layer structure it is also possible for condensate to be deposited on more than one plane as moisture evaporates from one surface and re-condenses on a colder one.

Interstitial condensation can cause deterioration of the building fabric, through corrosion, rot and decay. It can also reduce the thermal resistance of materials thus adversely affecting energy efficiency.

Direct solar radiation on moist building fabric can have the effect of driving moisture into the building fabric, leading to interstitial condensation on the external face of any vapour-tight inner layer.

This standard addresses the common condition in the UK, where buildings are occupied and heated during the winter months, creating a vapour pressure drive through the building envelope from the warm inside to the cold outside. By contrast, in warm moist climates, where it is common for buildings to be air conditioned, the vapour pressure drive will be from the warm outside to the cold inside: the external envelopes of such buildings have to be designed with this difference in mind. The increasing use of air conditioning units within existing buildings in the UK might well result in similar "outside to inside" vapour drives, creating an unforeseen risk of interstitial condensation.

Condensate which accumulates in the building fabric during winter can evaporate, partially or totally, during the following summer. Partial evaporation will lead to a long-term build up of condensate.

Annex B (informative)

Diagnosis of dampness problems

COMMENTARY ON ANNEX B

It is not possible to devise an infallible system for differentiating between condensation and other sources of dampness. A building element can be damp for a number of reasons, e.g. because of rising damp, condensation, water penetration, or presence of hygroscopic salts.

The following recommendations and guidance are intended to assist in an investigation.

B.1 History

It is advisable to make enquiries into the recent history of the building to determine whether it has been left unoccupied for any length of time or whether it has been open to the weather or flooded. If the building has remained unoccupied for some time, it will not be possible to determine every area in which condensation problems relating to occupancy have previously occurred; potential areas of risk should therefore be discovered by examination of the structure taking into account the proposed use of the building.

COMMENTARY ON B.1

The risk of interstitial condensation within the structure might need to be assessed using the methods set out in BS EN ISO 13788 (see Annex D).

Areas showing the effects of condensation, such as mould growth and staining, are more easily identified where a building has been occupied recently. If the inspection takes place during cold weather, while the premises are occupied or soon after they are vacated, damp patches might be evident.

B.2 Information from the occupants

The opportunity ought to be taken to obtain as much relevant information as possible from the occupants.

For example, the following factors may be considered.

- a) The number and ages of the occupants.
- b) The occupancy pattern.
- c) The heating pattern.
- d) Family economics, including how much is spent on heating.
- e) Types of domestic appliances which are likely to generate water vapour such

as cookers, washing machines, driers and free-standing room heating equipment such as portable gas or paraffin heaters.

- f) Whether the system for washing and drying clothes is one that will generate a lot of moisture within the dwelling.
- g) The weather and seasonal dependency of the phenomena.
- h) What means of ventilation is installed and whether it is used.
- i) Whether or not the family open the windows and when.

This information should be considered in the light of the principles outlined in Annex D to assist in an assessment of the building.

B.3 Monitoring temperatures and humidities

COMMENTARY ON B.3

Small, self contained, battery operated data loggers are now available which can record temperature and relative humidity at 15 min intervals for several months. These can be placed in each room in positions chosen as far as possible to represent the overall room conditions, and are small and robust enough to be returned by post to the surveyor, if it is not possible to revisit the house.

Data loggers should be placed against an internal wall between one metre and two metres above the floor. They should not be exposed to direct sun or heat from heating appliances, or other equipment such as a television. In many cases they may be placed on an appropriate item of furniture, but this is not always possible (some living rooms, for example have only a suite and television). It may be possible to fix the loggers to the wall with a picture hook, or with a suitable non-damaging adhesive.

At the end of the monitoring period, the recorded data may be downloaded from the loggers to a PC or laptop, using the software provided with the logger, and then transferred to a spreadsheet for analysis. The recorded temperatures and relative humidities may then be used to calculate the vapour pressure, an index of the amount of water vapour in the air using the equations in Annex C.

The simplest summary of the data collected is the overall means of the temperature and humidity in each room, however more information about the performance of the house may be gained from calculating daily means and the difference between the daily maximum and minimum temperature.

B.4 Causes of dampness

The causes of any dampness other than that resulting from condensation should first be determined. The following may be used as a checklist.

- a) Roof leaks, e.g. valleys, flashings around parapets and chimneys, and roof windows.
- b) Defects in the rainwater drainage system.
- c) Defects in wastepipes
- d) Leaks in the plumbing system.
- e) Rain penetration around the door and window openings.
- f) Defects in the damp-proof courses and membranes.
- g) Area of wall surface affected by hygroscopic elements, e.g. parapets, balconies and porches.

B.5 Recognition of surface condensation

Surface condensation occurs where the temperature falls below the dewpoint temperature of the adjacent air and can result in mould growth; this should be checked for in the following locations.

- a) Corners of rooms, especially corners of external walls.
- b) Lintels, reveals and sills.
- c) Behind furniture placed against external walls.
- d) Within built-in furniture on external walls.
- e) Floor/external wall junctions especially those containing ring beams.
- f) On the internal surface of north facing walls.

B.6 Recognition of hygroscopic effects

COMMENTARY ON B.6

Certain salts will absorb moisture from the atmosphere to such an extent that, if they are present in brickwork, damp patches will appear in plaster covering the bricks every time the weather becomes sufficiently humid and will fade away when dry weather returns.

The affected areas can relate to a single brick and such areas often show a well-defined edge. Typical locations to be affected are chimney breasts, brickwork previously affected by rising damp or damp penetration through the walls from adjoining structures.

B.7 Recognition of rising damp

COMMENTARY ON B.7

Water travelling through a wall contains dissolved salts and organic matter from the ground, particularly sulfate, chloride and nitrate salts. Sulfates are efflorescent and as the water evaporates at or just below the surface of the wall, these crystals form. When this occurs at the surface, the crystal forms a fragile feathery crystalline growth, usually white in colour and often forming "tide" marks. When it occurs below the surface, e.g. behind a paint film or plaster, the crystals grow and can disrupt the paint film or force the plaster off the wall. Chlorides and nitrates are hygroscopic and do not appear as crystals on the surface, rather they tend to show as tide marks at the maximum height of rise. Decorations are usually discoloured, wallpaper can be bleached or stained a brownish colour in these areas. The presence of chlorides tends to inhibit the growth of moulds, in effect producing saline conditions locally.

Rising damp gives a decreasing amount of free moisture from ground level upwards, when measured by gravimetric methods; care should be taken with a chemical absorption type meter as it will give high readings in regions contaminated by hygroscopic salts. Seawater flooding, for example, will give permanent high readings by chemical absorption due to the salt content of seawater, and the use of contaminated or unwashed sea-dredged materials in construction should also be borne in mind.

Care should be taken to differentiate between dampness due to condensation and due to rising damp; for example, because of the presence of a thermal bridge, or because of variations in air temperature or humidity at different points in a room, water can condense on a non-absorbent surface and form droplets. Rising damp should not be expected to appear in this form.

One of the most reliable ways that may be used to differentiate between dampness due to condensate and that due to rising damp is to compare moisture contents of samples of masonry, or preferably mortar, from within the depth of the wall and near the inner surface of the wall; samples from within the wall will not be damp if surface condensation is the sole cause.

NOTE More details of damp proofing treatments are given in BS 6576.

B.8 Measurement of dampness

Accurate measurements of the moisture content of brick or mortar cannot be obtained by the use of electrical moisture meters because the presence of salts increases the electrical conductance of the water, giving falsely high readings. Gravimetric methods carried out on samples taken from the fabric give the most reliable results. The use of chemical absorption type moisture meters will give a result in a short space of time and be almost as reliable.

Measurement methods for dampness in walls are discussed in more detail in BRE Digest 245 [2] and BRE Report 466 [3].

B.9 Damage caused by dampness

B.9.1 Damage to structure

Where inspection reveals damage, appropriate replacement, repair or preservative treatment ought to be carried out.

Any precautions against future condensation ought to ensure that further structural damage will be prevented. It is essential, therefore, that remedial treatment is directed to overcoming harmful interstitial condensation as well as surface condensation; freedom from the latter does not necessarily ensure that the former does not occur.

COMMENTARY ON B.9.1

The most likely forms of damage to a structure are decay in the timber or cellulose products, corrosion of metals, or excessive moisture movement of materials. Dampness can cause distortion and in some cases serious weakening of sheet or thin slab materials, e.g. in roof decks and ceilings. Moisture trapped beneath impermeable roof finishes can, in hot weather, cause vapour pressure high enough to cause damage to the roof finish.

B.9.2 Damage to finishes

COMMENTARY ON B.9.2

Damage to decoration occurs mainly from surface condensation, but occasionally can be caused by interstitial condensation, for example condensation dripping from an underlay onto a ceiling, or condensation in a wall moving inward and damaging surface finishes.

Mould growth on room surfaces, particularly in room corners, first appears as spots or small patches, which can spread to form a furry layer usually grey-green, black or brown in colour. On paint, it can show as pink or purple.

Soft distempers are liable to flake if repeatedly wetted and dried, whilst emulsion paints are more likely to remain undamaged. Moisture on the exposed surfaces tends to reduce the gloss of some impervious paints but otherwise does not cause damage. If moisture penetrates behind impervious paint films, blistering of the paint can occur. In extreme cases, the plaster can break down and/or lose its adhesion.

Repeated or prolonged absorption of condensate can cause distortion of sheet materials, e.g. plasterboard or fibreboard. Water absorbed from a surface can reach and break down an adhesive by which a surface finish is fixed. This can occur on floors or walls, but is more likely to be harmful in the case of ceilings when the effect of gravity adds to the risk of displacement of adhesive fixed tiles.

B.10 Mould growth*COMMENTARY ON B.10*

Mould growth is often associated with surface condensation. Damp houses provide good conditions for its development. Mould spores exist in large numbers in the atmosphere and, to germinate, need a nutrient, oxygen, a suitable temperature and moisture. Sources of nutrition are widespread in buildings and the internal environment provides a suitable temperature for growth. As oxygen is also always present, mould growth is principally dependent upon the moisture conditions at surfaces and the length of time these conditions persist.

Studies have shown that moulds do not necessarily require the presence of water. As a guide, if the average relative humidity within a room stays above 70% for several days, the relative humidity at external wall surfaces will be above 80%, which is high enough to support the germination and growth of moulds.

Although the symptoms of mould growth may be fairly easily dealt with by either washing with a household bleach diluted 1:4, followed by clean water, or the use of a proprietary toxic wash, it is better to remove the cause of the mould growth, i.e. the high relative humidities. Proprietary anti-fungal paints and wallpaper pastes, which may be used in areas where condensation occurs regularly, are also available (see BRE Digest 139 [4]).

**Annex C
(informative)****The temperature and moisture content of air**

All air supports water as an invisible vapour: the maximum amount of water vapour the air can support is determined by the temperature of the air – the warmer the air the more water vapour it can support. When air at a given temperature can support no more water vapour, that air is said to be saturated. When air which is not saturated is cooled, it will eventually reach the temperature at which it becomes saturated (that temperature is the dewpoint). Dewpoint for a given volume of air is solely dependent upon the quantity of water vapour which that air is supporting. The amount of water vapour present in a given volume of air can be expressed in kg/m³, and the vapour pressure it exerts can be expressed in kPa.

If the temperature of a given volume of saturated air is lowered, or more moisture is added, the air is unable to support the excess water vapour: liquid water will then appear, either as a fine mist or fog in the air or as condensate on any surface at or below dewpoint with which the air comes into contact.

The term relative humidity (usually expressed as %rh) is used to describe the amount of water vapour the air contains relative to that which would produce saturation at the given temperature.

Differences in the temperature and relative humidity of air in adjacent volumes create different vapour pressures as a result of which water vapour is transferred from areas of higher vapour pressure to those of lower vapour pressure. Vapour pressure is directly proportional to the amount of water vapour present.

Virtually all activities within buildings generate water vapour which increases the vapour pressure within the building (see Annex A).

Relative humidity and dewpoint are the two most important parameters which determine whether condensation occurs. Although dewpoint is expressed as a temperature, it is dependent upon the amount of moisture present in the air. Air moisture content and percentage relative humidity may be determined by using a wet and dry bulb psychrometer or electronic hygrometer.

The relative humidity of the ambient air determines how much moisture will be absorbed by hygroscopic materials; this in turn determines the risk of mould growth on surfaces and the decay of materials. The psychrometric chart in Figure C.1 demonstrates the relationship between relative humidity and dewpoint. The curved lines show relative humidity, the 100% line being saturation (dewpoint).

Figure C.1 Psychrometric chart showing the derivation of relative humidity from temperature and vapour pressure

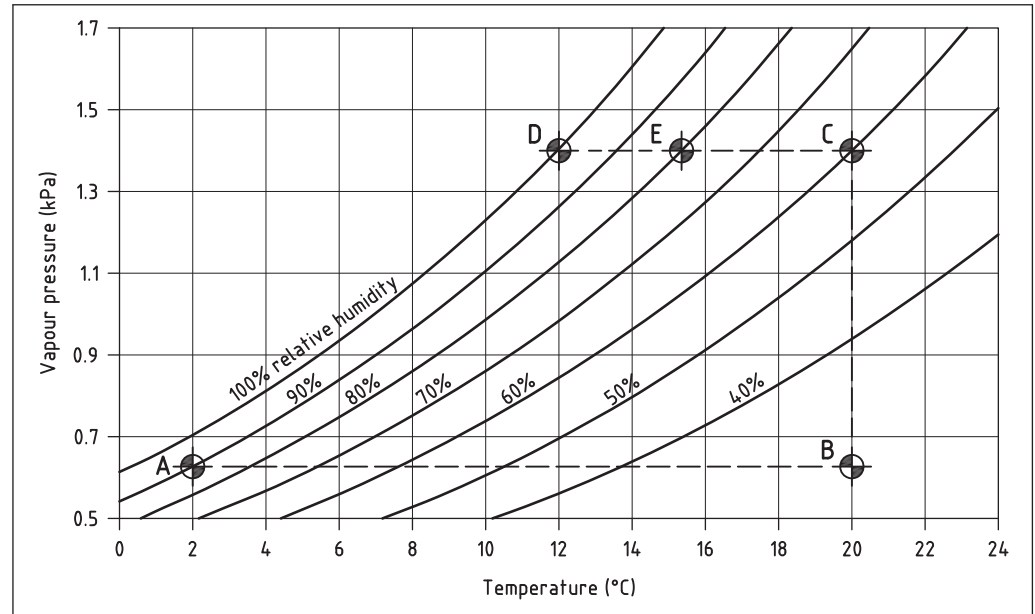

Point A represents a given volume of air at temperature 2 °C with a vapour pressure of 0.60 kPa: its relative humidity is therefore 90%.

Point B represents that same volume of air, with the same moisture content (and, therefore, the same vapour pressure) but heated to 20 °C; its relative humidity will now be approximately 24%. This illustrates what happens when outside air enters a building and is warmed.

Point C indicates that same volume of air at 20 °C, to which moisture has been added to bring its vapour pressure to about 1.4 kPa. That increase in moisture with no change in temperature means the relative humidity of the air has increased to about 60%. This illustrates what happens when that warmed incoming air absorbs moisture from activities within a building, but is not heated.

Point D illustrates that saturation of that air will occur if it is cooled to its dewpoint temperature of about 11.9 °C; any further reduction in temperature will result in condensation occurring.

Point E on the chart indicates that 80%rh will occur if the temperature of the given volume of air falls to approximately 15 °C. The risk of mould growth occurring when relative humidity at a surface reaches 80%, as described in A.5. This illustrates that designing to avoid surface mould growth is more onerous than designing to avoid condensation.

Equations C.1 to C.10 may be used to model the behaviour of water vapour in air inside and outside buildings; the most important relationship is that between air temperature T and saturation vapour pressure SVP . In the following equations vapour pressure is expressed in kilopascals (kPa)¹⁾.

¹⁾ To convert kPa to millibars (mb) multiply by 10.

Equation C.1 and Equation C.2 are used in BS EN ISO 13788 to produce a close approximation to the SVP over the normal range of temperatures found in UK buildings. They may be inverted to calculate dewpoint from vapour pressure (see Equation C.3 and Equation C.4).

$$\text{SVP} = 0.6105 \exp\left(\frac{17.269T}{237.3+T}\right) \quad (\text{for } T \geq 0 \text{ } ^\circ\text{C}) \quad (\text{C.1})$$

$$\text{SVP} = 0.6105 \exp\left(\frac{21.875T}{265.5+T}\right) \quad (\text{for } T < 0 \text{ } ^\circ\text{C}) \quad (\text{C.2})$$

where:

T is the dry bulb temperature in $^\circ\text{C}$.

NOTE The figure 237.3 in Equation C.1 is correct, it is not to be confused with the figure 273.3 used to convert degrees centigrade to Kelvin.

To calculate dewpoint T_{dp} from vapour pressure p in kPa:

$$T_{\text{dp}} = \frac{237.3 \log_e\left(\frac{p}{0.6105}\right)}{17.269 - \log_e\left(\frac{p}{0.6105}\right)} \quad (\text{for } p \geq 0.6105 \text{ kPa}) \quad (\text{C.3})$$

$$T_{\text{dp}} = \frac{265.5 \log_e\left(\frac{p}{0.6105}\right)}{21.875 - \log_e\left(\frac{p}{0.6105}\right)} \quad (\text{for } p < 0.6105 \text{ kPa}) \quad (\text{C.4})$$

To calculate vapour pressure p from dry bulb temperature T_{d} and percentage relative humidity φ .

$$p = \text{SVP}(T_{\text{d}}) \times \frac{\varphi}{100} \quad (\text{C.5})$$

where:

$\text{SVP}(T_{\text{d}})$ is the saturated vapour pressure at the dry bulb temperature calculated from Equation C.1 or Equation C.2.

To calculate vapour pressure from dry bulb T_{d} and wet bulb T_{w} temperatures:

$$p = \text{SVP}(T_{\text{w}}) - AP(T_{\text{d}} - T_{\text{w}}) \quad (\text{C.6})$$

where:

$\text{SVP}(T_{\text{w}})$ is the saturated vapour pressure at the wet bulb temperature calculated from Equation C.1 or Equation C.2.

A is a constant equal to 0.000 666

P is the total atmospheric pressure in kPa

Equation C.6 can usually be simplified by assuming that $P = 100$ kPa giving:

$$p = \text{SVP}(T_{\text{w}}) - 0.0667(T_{\text{d}} - T_{\text{w}}) \quad (\text{C.7})$$

To calculate percentage relative humidity from dry bulb temperature T_{d} and vapour pressure p :

$$\varphi = 100 \frac{p}{\text{SVP}(T_{\text{d}})} \quad (\text{C.8})$$

where:

$SVP(T_d)$ is the saturated vapour pressure at the dry bulb temperature calculated from Equation C.1 or Equation C.2.

To calculate the moisture content of the air v , in g/m^3 , from vapour pressure p , in kPa:

$$v = \frac{2170p}{T_d + 273.3} \quad (\text{C.9})$$

where:

T_d is the dry bulb temperature in $^{\circ}\text{C}$.

To calculate the moisture content of the air x , in g/kg of dry air, from vapour pressure p , in kPa:

$$x = \frac{622p}{P - p} \quad (\text{C.10})$$

where:

P is the total atmospheric pressure in kPa.

Annex D
(normative)
D.1

Calculating condensation risk

General

BS EN ISO 13788 contains recommended procedures for the assessment of the risk of:

- mould growth;
- surface condensation;
- interstitial condensation.

D.2 Mould growth and surface condensation

If the relative humidity of the air in a room exceeds 70%, the surface relative humidity of an external element is likely to exceed 80%. If that occurs for more than two or three days, mould is likely to develop on the surface. Surface relative humidity is determined by the internal vapour pressure and the surface temperature of the external element, which depends upon the nature of the construction. The presence of thermal bridges such as those around doors and windows produces lower local temperatures.

BS EN ISO 13788 contains a method for calculating monthly mean surface temperatures of a building element or component given internal and external temperatures, which can be combined with information on moisture production and ventilation rate to calculate the surface relative humidity. The method uses three parameters, together with external climate data, to determine the risk of mould growth and surface condensation, those parameters are:

- a) the internal moisture supply (see **D.3.3**);
- b) the internal air temperature;
- c) the temperature factor of the internal surface f_{Rsi} , which takes account of the thermal resistance and geometry of the materials present and the internal surface resistance R_{si} (see Table E.5); f_{Rsi} is defined by Equation D.1.

$$f_{Rsi} = \frac{\theta_{si} - \theta_e}{\theta_i - \theta_e} \quad (\text{D.1})$$

where:

- θ_i is the internal air temperature in °C;
 θ_e is the external air temperature in °C;
 θ_{si} is the temperature of the internal surface in °C.

The design requirements for avoidance of mould growth are more onerous than those for the avoidance of surface condensation.

The principal steps in the design procedure are to determine, for each month of the year:

- 1) the internal air vapour pressure;
- 2) the vapour pressure p_{sat} at the surface, which will result in a surface relative humidity not greater than 80%;
- 3) the minimum surface temperature and hence the required temperature factor f_{Rsi} of the building envelope.

D.3 Interstitial condensation

D.3.1 Principles

BS EN ISO 13788 describes a method (known as the “Glaser method”) for predicting the risk of interstitial condensation occurring under specified environmental conditions. The method indicates how much condensate will be deposited, how much will evaporate and any balance which might accumulate year on year. The method uses monthly mean external conditions to calculate the amount of condensate deposited and/or evaporated in each of twelve months, following the first predicted occurrence of condensation.

The method is a useful assessment tool, suitable for comparing different constructions and assessing the effects of design changes. It assumes one-dimensional, steady state conditions and does not consider air movements within or through the construction and makes no allowance for the moisture in the materials or rainwater absorbed during construction. Consequently, while it is useful for comparing the performance of different structures, it does not provide an accurate prediction of moisture conditions within the structure under service conditions. More advanced methods, which are standardized in BS EN 15026, are available and are described more fully in [5].

D.3.2 External climatic data

D.3.2.1 Walls, roofs and exposed floors

The calculation method described in BS EN ISO 13788 requires monthly mean external temperature and vapour pressure data. Monthly mean temperature data for many locations may be obtained relatively easily, but vapour pressure data are much more difficult to obtain. The most useful source is the CD ROM *International Station Meteorological Climate Summary, Version 3.0* available from the US National Climate Data Centre, which contains information from many weather stations around the world, including 43 in the UK. Table D.1 summarizes mean temperatures and relative humidities (calculated from the mean temperature and mean vapour pressure) for London, Manchester and Edinburgh.

The data in Table D.1 are derived from long term averages: they may be used for calculating parameters such as the long term energy performance of a building; they are less appropriate for assessing the risk of condensation using the criteria given in BS EN ISO 13788, because more severe conditions from one year to the next might well result in more condensation than predicted. It is better to use the worst climate predicted to occur once in N years where N is a number which reflects the likely consequences of condensation occurring in the building under consideration. For example, ten years might be appropriate for most buildings, whereas 50 years might be appropriate for a computer centre.

Condensation risk years with various return periods can be created by applying the corrections shown in Table D.2 to the monthly temperatures and relative humidities of any mean year.

Designers should be aware that data measured at airfields does not accurately represent conditions in city centres or on high ground.

Table D.1 Monthly mean temperature and relative humidity for interstitial condensation calculations

Month	Heathrow (London)		Ringway (Manchester)		Turnhouse (Edinburgh)	
	T °C	Rh %	T °C	rh %	T °C	rh %
Jan	4.9	84	4.2	83	3.5	83
Feb	4.7	82	4.1	80	3.7	81
Mar	6.9	77	5.8	76	5.3	78
Apr	8.8	71	7.8	71	7.0	75
May	12.6	69	11.3	68	9.9	75
Jun	15.7	69	14.1	71	12.8	75
Jul	17.9	68	16.1	72	14.7	76
Aug	17.6	70	15.8	74	14.4	78
Sep	14.9	75	13.3	77	12.1	80
Oct	11.2	81	10.3	81	9.2	82
Nov	7.6	84	6.7	82	5.8	83
Dec	5.9	86	5.2	84	4.3	84

Table D.2 Corrections to monthly mean temperatures and relative humidities to create condensation risk years with various return periods

Return period	Temperature °C	Relative humidity %
1 in 5	-1	+2
1 in 10	-1	+4
1 in 20	-2	+4
1 in 50	-4	+6

D.3.2.2 Ground bearing floors

The risk of interstitial condensation in a ground bearing floor may be calculated by including 2 m of soil below the floor structure in the calculation and taking the external conditions as the monthly mean temperature at 2 m below the floor and a constant 100% relative humidity. The external air temperature and humidity should still be used to calculate the internal vapour pressure as described in D.3.4.

Heat flow into the ground is a complex process, which depends on many factors; these are discussed fully in BS EN ISO 13370. Two factors should be taken into consideration when selecting a realistic temperature for use in interstitial condensation calculations.

- The temperature in the ground below a building is affected by the presence of the building; the ground is significantly warmer below the centre of a building than below the edge of the building.
- The large thermal inertia of the ground means that ground temperatures lag appreciably behind the external air temperature; the minimum temperature at 2 m below ground is about a month later than the minimum air temperature.

A full analysis using three dimensional non-steady state thermal software should be used to provide precise values, however a reasonable estimate of the monthly mean temperatures in the ground 2 m below the floor may be made by the following steps.

- Take the 12 monthly mean external air temperatures, θ_m .
- Average these to give the annual mean external air temperature, θ_{an} .
- For each month calculate the average of the θ_m and θ_{an} , i.e. $(\theta_{an} + \theta_m)/2$.
- Displace the calculated values by one month, so the January value becomes February, etc.

This process is illustrated for the Heathrow data from Table D.1 in Table D.3.

Table D.3 Example of the calculation of estimated ground temperatures

	Monthly mean, θ_m	$(\theta_{an} + \theta_m)/2$	Ground temperature, θ_g
January	4.9	7.8	8.3
February	4.7	7.7	7.8
March	6.9	8.8	7.7
April	8.8	9.8	8.8
May	12.6	11.7	9.8
June	15.7	13.2	11.7
July	17.9	14.3	13.2
August	17.6	14.2	14.3
September	14.9	12.8	14.2
October	11.2	11.0	12.8
November	7.6	9.2	11.0
December	5.9	8.3	9.2
Annual mean, θ_{an}	10.7		

D.3.2.3 Suspended ground floors

The ventilated space between the structure of a suspended floor and the ground is at a temperature intermediate between the external air and the internal temperature of the building. Monthly values of this subfloor temperature, together with the outside vapour pressure, should be used for the external boundary conditions for interstitial condensation calculations. The external air temperature and humidity should still be used to calculate the internal vapour pressure as described in **D.3.4**.

The subfloor temperature depends on many parameters, including the internal and external temperatures, the thermal resistance of the floor structure and perimeter walls, the dimensions of the building and the amount of ventilation provided to the subfloor space. Algorithms that may be used for the calculation of the subfloor temperature are given in BS EN ISO 13370, Annex E and these are implemented in some software packages used for U-value calculations.

For detached and terraced housing and buildings of a similar size, with 0.0015 m² of subfloor ventilators per metre length of perimeter, the subfloor temperature may be approximated by:

$$\theta_{sf} = \theta_e + X_r(\theta_i - \theta_e) \text{ (in } ^\circ\text{C)}$$

where:

- θ_{sf} is the sub-floor temperature in $^\circ\text{C}$
- θ_i is the internal air temperature in $^\circ\text{C}$
- θ_e is the external air temperature in $^\circ\text{C}$
- X_r is a factor that depends on the thermal resistance of the floor structure and the building type

where:

$$X_r = 0.0079R_f^2 - 0.1126R_f + 0.683, \text{ for terraced houses}$$

$$X_r = 0.0073R_f^2 - 0.1057R_f + 0.508, \text{ for detached houses}$$

where:

$$R_f \text{ is the thermal resistance of the floor structure in m}^2\text{K/W}$$

D.3.3 Internal climatic data – Design data – Moisture generation rates

Table D.4 gives the typical amounts of water vapour generated in houses with various numbers of occupants.

All fuels give off some water vapour when burned; Table D.5 gives the amounts produced by different fuels. In most cases this vapour will be extracted to the outside along with flue gases; however unflued appliances will substantially increase the rate of water vapour generation.

Table D.6 gives a typical moisture generation rates for specific household activities.

Table D.4 Moisture production rates in housing

Number of occupants	Average moisture production rate, kg/day		
	Low (One or two people, no children)	Medium (Average family with children)	High (Family with teenage children, indoor drying of laundry etc).
1	3 to 4	6	9
2	4	6	11
3	—	9	12
4	—	6	14
5	—	11	15
6	—	12	16

Table D.5 Typical moisture production rates from fuels

Fuel	Moisture release g/kWh
Natural gas ^{A)}	150
Manufactured gas ^{A)}	100
Paraffin	100
Portable LPG	100
Coke ^{A)}	30
Coal ^{A)}	10
Electricity	0

^{A)} The majority of heating appliances using these fuels are ventilated to the outside air. Consequently the water vapour produced by combustion is not released directly into the dwelling.

Table D.6 Typical moisture generation rates for household activities

Household activity	Moisture generation rates
People	40 g/h·person
asleep	70 g/h·person
seated, office work	90 g/h·person
standing, housework	300 g/h·person
moderate manual work	
Cooking	2 000 g/day
electricity	3 000 g/day
gas	
Dishwashing	400 g/day
Bathing/washing	200 g/day·person
Shower (15 min)	600 g/shower
Washing clothes	500 g/day
Drying clothes indoors	1 500 g/day
Washing floors	200 g/day
Plants	20 g/day·plant

D.3.4 Other buildings

Much less information is available covering buildings other than housing. However, the concept of classes of internal humidity load can be helpful. This concept is based on the assumption that the difference between the internal and external vapour pressure, the internal humidity load, depends upon the amount of moisture produced within the building and upon the ventilation rate.

$$\Delta p = p_i - p_e = \frac{C}{0.191NV}$$

where

- V is the total building volume in m^3
- N is the ventilation rate in ac/h
- C is the daily moisture input in kg/day.

As the external temperature falls, Δp will rise because ventilation rates fall.

Internal humidity load can be described by five humidity classes. Figure D.1 shows limit values of Δv and Δp for each class as a function of external temperature, derived from measured data. Table D.7 shows the types of buildings expected to fall into each class and the range of relative humidities covered by the class in buildings with different internal temperatures, at an external temperature of 0 °C and a relative humidity of 95 %.

For calculations, it is recommended that the upper limit value for each class be used unless the designer can demonstrate that conditions are less severe.

Wherever possible, measured data should be used for the analysis of buildings in class 5, with high internal humidities. The dotted line on Figure D.1 gives suggested values which may be used in the absence of other data.

Figure D.1 Variation of internal humidity classes with external temperature

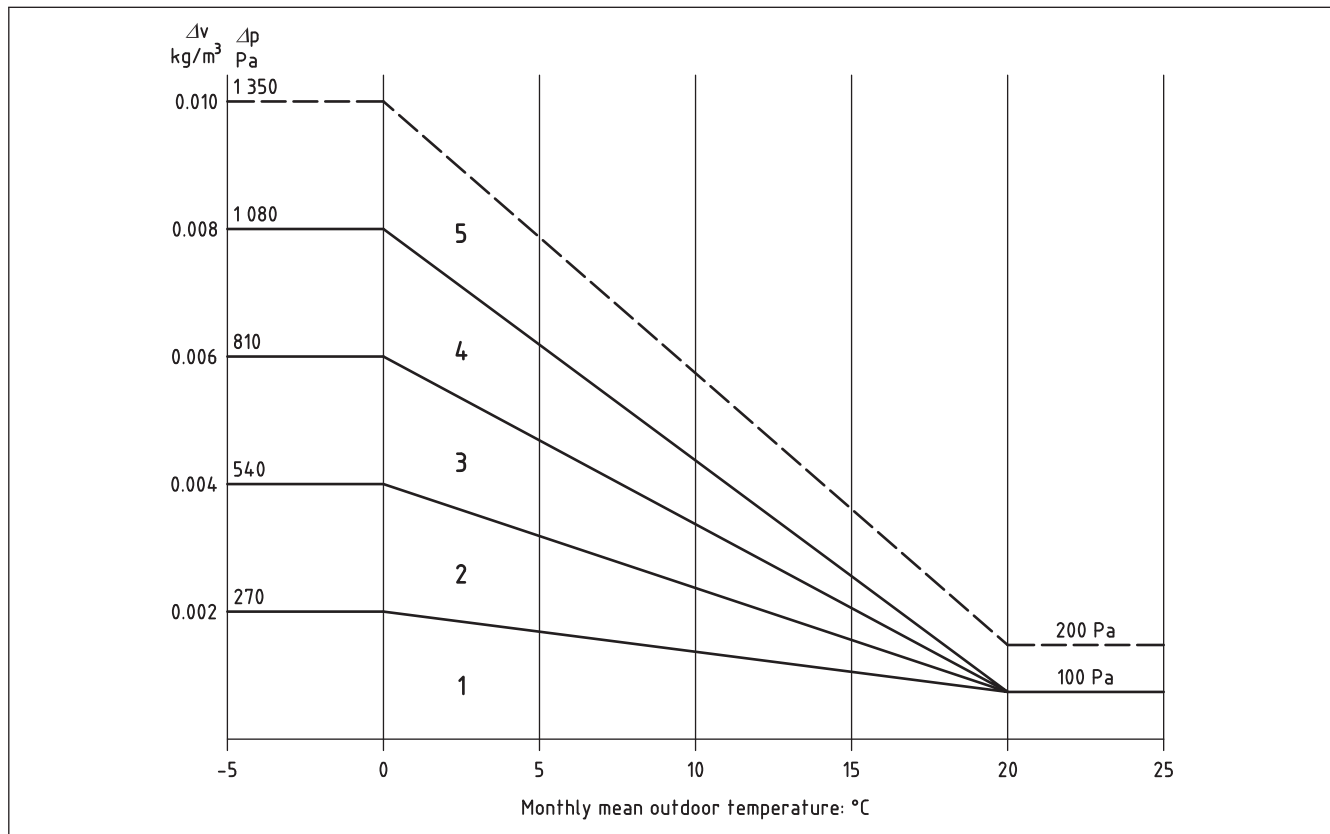
Table D.7 Internal humidity classes: building types and limiting relative humidities at $T_3 = 0\text{ °C}$

Humidity class	Building type	Relative humidity at internal temperature		
		15 °C	20 °C	25 °C
1	Storage areas	< 50	< 35	< 25
2	Offices, shops	50–65	35–50	25–35
3	Dwellings with low occupancy	65–80	50–60	35–45
4	Dwellings with high occupancy, sports halls, kitchens, canteens, buildings heated with unflued gas heaters	80–95	60–70	45–55
5	Special buildings, e.g. laundry, brewery, swimming pool.	> 95	> 70	> 55

D.3.5 Limitations of the Glaser method

This method assumes moisture transfer is affected solely by diffusion; thermal conductivity and thermal resistance of materials are assumed constant; the effects of phase changes and the specific heat capacity of materials are ignored. These simplifications ignore the following, and give rise to several errors.

- Air movements within or through the construction will redistribute moisture by convection.
- The use of constant material properties is an approximation: precipitation and water used in construction increase the moisture content of materials; the thermal conductivity of a material depends on its moisture content.

- c) Changes in the distribution of moisture within a construction will be caused by capillary action within absorbent materials: most materials are hygroscopic to some degree.
- d) Heat released by condensation or absorbed during evaporation changes temperature and vapour pressure within the structure.
- e) Environmental conditions are not constant over a month.
- f) The effects of radiation are ignored.
- g) If an element experiences large diurnal temperature changes and is likely to contain significant amounts of moisture the results of analysis using this method have to be treated with caution, they are likely to overestimate the risk of interstitial condensation.
- h) If there is significant air movement within or through an element the results of analysis will be unreliable and have to be applied with caution.

D.4 Calculation of condensation risk in a pitched roof with thermal insulation applied on a horizontal ceiling

The primary method of water vapour transfer into such a roof is mass air movement caused by stack effect within the occupied space and by external wind forces, both of which transfer water vapour through gaps and holes in the ceiling into the loft.

The method for assessing the risk of interstitial condensation described in D.3 is unsuitable for use for determining condensation risk for such roofs as it takes account only of water vapour transport by diffusion, ignores the effects of airflow, uses monthly mean temperatures and does not include the effects of radiation to the night sky or of solar gain. Suitable methods for calculating the risk of interstitial condensation in such roofs are described in BRE information paper IP 5/06 [5].

Annex E (informative)

Properties of materials

E.1 Conductivity and vapour resistivity

Table E.1 lists the thermal conductivity and vapour resistivity of a number of common building materials; these values combined with material dimensions should be used in calculations. Independently certified values should be used when available. In the absence of such data, the values given in Table E.1 are the best currently available. The values given are for the material alone; actual value when installed might be considerably lower as a result of joints, penetrations and workmanship defects. Where an infinite value of vapour resistivity is given, it is advisable to substitute a value of 100 000 MN·s/g·m for calculations.

Table E.1 Thermal conductivity and vapour resistivity of building materials (1 of 3)

Material	Density	Thermal conductivity	Vapour resistivity	
	kg/m ³		W/m·K	Typical MN·s/g·m
Fibre cement sheeting	700	0.36	300	200 – 1 000
Mastic asphalt	2 100	1.20	∞	∞
Block				
lightweight	600	0.22	30	20 – 50
medium weight	1 400	0.50	50	30 – 80
dense	2 050	1.20	100	60 – 150
Brick				
common/inner leaf	1 700	0.56	50	25 – 100
common/outer leaf	1 700	0.77	50	25 – 100
engineering	2 000	1.25	120	100 – 250
Carpeting				
with cellular rubber underlay	400	0.10	200	100 – 300
with synthetic underlay	160	0.06	200	100 – 300
Concrete (cast)				
aerated, cellular	400	0.15	50	
aerated	850	0.29	100	
medium weight	1 350	0.59	150	
dense	2 200	1.70	200	
no fines	1 800	0.96	20	
Mineral wool (glass or rock)	12	0.04	5	
Glass				
sheet	2 500	1.0	∞ ^{A)}	∞
expanded or foamed	140	0.05	∞ ^{A)}	
Metals				
aluminium	2 700	160	∞ ^{A)}	
copper	8 600	384	∞ ^{A)}	
iron	7 900	72	∞ ^{A)}	
lead	11 340	35	∞ ^{A)}	
steel	7 800	50	∞ ^{A)}	
stainless steel	8 000	17	∞ ^{A)}	
tin	7 300	65	∞ ^{A)}	
zinc	7 000	113	∞ ^{A)}	
Mortar				
outer leaf		0.94		
inner leaf		0.88		
Plaster				
gypsum	1 120	0.51	50	30 – 60
lightweight	720	0.22	30	20 – 50

Table E.1 Thermal conductivity and vapour resistivity of building materials (2 of 3)

Material	Density kg/m ³	Thermal conductivity W/m·K	Vapour resistivity	
			Typical MN·s/g·m	Range MN·s/g·m
Plasterboard				
standard	700	0.21	60	
acoustic or fire resistant	900	0.25		
Plastic foams				
phenol	30	0.04	50	150 – 750
polyisocyanurate	45	0.03	50	150 – 750
polyurethane	30	0.03	120	115 – 1 000
polyvinylchloride	37	0.035		40 – 1 300
urea formaldehyde	10	0.04		5 – 20
Polystyrene				
expanded bead	20	0.035	300	100 – 600
expanded extruded	30	0.027	1 000	600 – 1 300
PVC (polyvinylchloride) sheet or tile	1 390	0.16		800 – 1 300
Rendering	1 600	0.8	100	
Roof coverings				
clay roof tiles	2 000	0.84		
concrete roof tiles	2 100	1.50		
slates	2 500	2.20		
Rubber				
natural	910	0.13	4 500	
neoprene	1 240	0.23	4 500	
butyl	1 200	0.24	4 500	
foam rubber	70	0.06	4 500	
EPDM	1 150	0.25	4 500	
polyisobutylene	930	0.20	4 500	
Screed				
aerated	700	0.40		
cast	2 100	1.40		
Soil				
clay or silt	1 500	1.50	100	
sand or gravel	1 800	2.00	50	
Stone				
basalt, gneiss, marble	2 700	3.50	∞ ^{A)}	150 – ∞
granite	2 500	3.50		150 – ∞
slate	2 400	1.40		350 – ∞
limestone, hard	2 200	2.30		130 – ∞
limestone, soft	1 800	1.80		75 – ∞
sandstone	2 600	2.30		30 – ∞
pumice	400	0.12		

Table E.1 Thermal conductivity and vapour resistivity of building materials (3 of 3)

Material	Density	Thermal conductivity	Vapour resistivity	
	kg/m ³		W/m·K	Typical MN·s/g·m
Tiling (ceramic)	2 300	1.30		750 – 1 500
Timber				
softwood	500	0.13		90 – 700
hardwood	700	0.18		200 – 1 500
Vermiculite	260	0.07	15	
Wood based panels				
cement bonded particleboard	1 200	0.23		19 – 50
particleboard	300	0.10		300 – 500
particleboard	600	0.14		500 – 700
oriented strand board (OSB)	650	0.13		200 – 500
woodwool slabs	600	0.10		15 – 40
hardboard	880	0.12		250 – 1 000
sheathing plywood	500	0.13		150 – 1 000
decking plywood	700	0.17		1 000 – 6 000
fibre board	250	0.07		150 – 400
medium density fibreboard	600	0.14		300 – 600
cork board	110	0.04		25 – 50

^{A)} The higher figure quoted is a notional value for the purposes of calculation.

Based on CIBSE Guide A3 [6]

NOTE Further data are given in CIBSE Guide A3 [6] and BS EN 12524.

E.2 Vapour resistances of thin membranes and foils

Table E.2 lists the vapour resistances of a number of thin membranes and foils; they may be used directly in calculations.

The values given are for the material alone; actual value when installed might be considerably lower as a result of joints, penetrations and workmanship defects. Thermal resistance of the materials may be considered as negligible for the purposes of calculation.

The values given are the best currently available: it is advisable to use independently certified values when available.

Table E.2 Vapour resistances of thin membranes and foils

Material	Vapour resistance	
	Typical MN·s/g	Range MN·s/g
Aluminium foil	1 000	200 – 4 000
Mastic asphalt	∞ ^{A)}	
Breather membrane	0.5	0.25 – 0.6
High vapour resistance membrane	—	1.0 – ∞
Low vapour resistance underlay (type LR)	0.2	0.08 – 0.25
High vapour resistance underlay (type HR)	—	0.25 – ∞
Building paper (bitumen impregnated)	10	
Reinforced bitumen membrane roofing felt laid in bitumen Type 1F felt	1 000 450	
Glass (sheet)	∞ ^{A)}	
Metals and metal cladding	∞ ^{A)}	
Paint	0.5	8 – 40
emulsion	15	
gloss vapour resistant	25	
Polyester film (0.2 mm)	250	
Polyethylene	250	200 – 350
500 gauge (0.12 mm)	500	400 – 600
1 000 gauge (0.25 mm)		
Vinyl wallpaper	10	

^{A)} The values shown are notional values for the purpose of calculation.

E.3 Thermal resistance of cavities

The thermal resistance of a cavity in building construction depends on its inclination, depth, the degree of ventilation and the emissivity of the bounding surfaces.

The values given in Table E.3 apply to an unventilated cavity which:

- a) contains air;
- b) has no air interchange with the internal environment;
- c) is bounded by two faces effectively perpendicular to the direction of heat flow, each having emissivities not less than 0.9; and
- d) in the direction of heat flow, has a thickness of less than a tenth of any other dimension of the cavity and in any case not more than 0.3 m.

The resistance of any other cavity may be calculated as specified in BS EN ISO 6946:2007, Annex B.

BS EN ISO 6946:2007 distinguishes three degrees of ventilation:

- 1) unventilated;
- 2) slightly ventilated; and
- 3) well ventilated.

Unventilated. A cavity may be treated as unventilated if the openings to outside air do not exceed 500 mm²/m length for a vertical air layer and 500 mm²/m² of surface area for a horizontal air layer.

Slightly ventilated. A cavity may be treated as slightly ventilated if it has openings to outside air A_v of:

- for vertical air layers, between 500 mm²/m length and 1 500 mm²/m length;
- for horizontal air layers, between 500 mm²/m² of surface area and 1 500 mm²/m² of surface area.

The total thermal resistance of a component with a slightly ventilated air layer may be calculated from:

$$R_T = \frac{1\,500 - A_v}{1\,000} R_{T,u} + \frac{A_v - 500}{1\,000} R_{T,v}$$

where:

- $R_{T,u}$ is the total resistance of the component with an unventilated air layer,
- $R_{T,v}$ is the total resistance of the component with a well ventilated air layer.

Well ventilated. A cavity may be treated as well ventilated if it has openings to outside air A_v of:

- for vertical air layers, in excess of 1 500 mm²/m length;
- for horizontal air layers: in excess of 1 500 mm²/m² of surface area.

When calculating the total thermal resistance of a building component containing a well-ventilated cavity, the cavity and materials beyond it may be disregarded and the external surface resistance may be taken as equal to the internal surface resistance; i.e. $R_{T,v}$ is taken as the internal surface resistance.

NOTE BS EN ISO 6946:2007 gives further information about the thermal resistance of cavities.

Table E.3 Thermal resistance, in m²K/W, unventilated cavities 5 mm and 25 mm wide with high emissivity surfaces

Heat flow direction	5 mm	25 mm
Horizontal	0.10	0.18
Upwards	0.10	0.16
Downwards	0.10	0.19

E.4 Pitched roofs

In a pitched roof with a flat insulated ceiling and ventilation of the space between roof covering and ceiling, the roof space (loft) may be regarded as a thermally homogeneous layer with thermal resistance as given in Table E.4.

The data in Table E.4 apply to naturally ventilated roof spaces above heated buildings. If mechanically ventilated, the detailed procedure in BS EN ISO 13789 should be used, treating the roof space as an unheated space with a specified ventilation rate.

If the roofspace is not ventilated its thermal resistance may be calculated as defined in BS EN ISO 13789.

Table E.4 Thermal resistance of roof spaces

Type of roof covering	R_u m ² K/W
Tiled or slated, no boarding or underlay	0.06
Tiled or slated with boarding and underlay	0.3
Tiled or slated with boarding or underlay	0.2
As above, but with low emissivity internal lining	0.3
Sheet metal	0.2

NOTE The values in this table include the thermal resistance of the ventilated space and thermal resistance of the (pitched) roof construction. They do not include the external surface resistance, R_{se} .

E.5 Vapour properties of cavities

The vapour resistivity of still air is 5 MN·s/g·m. As a result of ventilation and/or convection the air in a cavity is never still: consequently, when carrying out interstitial condensation calculations, the vapour resistivity of air in cavities may be taken as zero.

E.6 Thermal resistances of surfaces

Table E.5 gives the standard internal and external surface thermal resistances.

Surface resistance is also affected by surface emissivity, however the internal and external surfaces of buildings always have a high emissivity, and the surface resistances in Table E.5 may be used.

Table E.5 Thermal resistances of surfaces

Heat flow direction	Element	Internal surface R_{si} m ² K/W	External surface R_{se} m ² K/W
Horizontal	Wall, window	0.13	0.04
Upwards	Roof	0.10	0.04
Downwards	Floor	0.17	0.04

E.7 Factors for the conversion of vapour permeability and vapour permeance

Throughout this standard, the vapour resistance or resistivity of materials is used since this is analogous with heat transfer. There are two ways of describing the vapour transfer property of any material: either by reference to a one metre thickness of that material (resistivity) or by reference to a layer of given thickness (resistance). Vapour permeability is the inverse of vapour resistivity whereas vapour permeance is the inverse of vapour resistance. Vapour transfer characteristics are expressed in the following units.

Vapour resistance	MN·s/g	
Vapour permeance	μg/N·s	(g/MN·s)
Vapour resistivity	MN·s/g·m	
Vapour permeability	μg·m/N·s	(g·m/MN·s)

When undertaking calculations for interstitial condensation, it is suggested that the values of vapour resistance or resistivity quoted in this annex be used. If it is required to convert values expressed as permeance the conversion factors listed in Table E.6 may be used. Subsequently, take the inverse to obtain a value of resistance.

Table E.6 Factors for converting permeance units to $\mu\text{g}/\text{N}\cdot\text{s}$

Unit as originally expressed	Multiplication factor
$\text{g}/(\text{cm}^2\cdot\text{s}\cdot\text{mbar})$	1×10^8
$\text{g}/(\text{m}^2\cdot 24\text{h}\cdot\text{mmHg})$ [metric perm]	9.681×10^{-2}
$\text{Lb}/(\text{ft}^2\cdot\text{h}\cdot\text{atm})$	1.339×10
$\text{gr}/(\text{ft}^2\cdot\text{h}\cdot\text{mb})$ ^{A)}	1.937
$\text{gr}/(\text{ft}^2\cdot\text{h}\cdot\text{inHg})$ ^{A)} [perm]	5.719×10^{-2}
Temperate (75% r.h., 25 °C), $\text{g}/(\text{m}^2\cdot 24\text{h})$ [BS 2972]	4.874×10^{-3}
Tropical (90% r.h., 38 °C), $\text{g}/(\text{m}^2\cdot 24\text{h})$ [BS 2972]	1.942×10^{-3}
$\text{mg}/(\text{Nh})$	2.78×10^{-4}

^{A)} gr = grains.

E.8 European units

European standards (including BS EN ISO 13788) and manufacturers' data sheets commonly quote vapour resistivities or resistances in the form of the water vapour resistance factor μ , or the equivalent air layer thickness s_d . These are defined by:

$$\mu = \delta_a / \delta \quad \text{and} \quad s_d = \mu d$$

where:

- δ_a is the vapour permeability of still air in $\text{g}\cdot\text{m}/\text{MN}\cdot\text{s}$
- δ is the vapour permeability of the material in $\text{g}\cdot\text{m}/\text{MN}\cdot\text{s}$
- d is the thickness of a sample of material in m.

The permeability of air δ_a varies with temperature and atmospheric pressure (further details are given in BS EN ISO 12572). However, a value of $0.2 \text{ g}\cdot\text{m}/\text{MN}\cdot\text{s}$ should be taken as typical of UK conditions. Therefore to convert a μ value to a vapour resistivity in the units given in Table E.1, multiply by 5.

Similarly, to convert an s_d value into a vapour resistance in the units given in Table E.2, multiply by 5.

Annex F (normative) F.1

Application of design principles – Floors

General considerations

The designer should take account of the following sources of moisture which can affect floors in buildings:

- a) ground moisture;
- b) construction moisture; water incorporated in screeds, pre-cast units and concrete slabs is released as the constructions dry out and can cause degradation of floor finishes: sufficient time has to be allowed for drying out, particularly where a concrete slab is formed above a damp-proof membrane (refer to BS 8204 [all parts]); as a guide, a concrete slab will require one month's drying for every 25 mm of thickness up to 150 mm thick; slabs of greater thickness can take much longer to dry;
- c) moisture generated by the occupants and their activities, which are liable to change during the life of the building; and
- d) leaks resulting from defects in the external envelope or in piped services and spillage within the building which might cause damage to the structure or finishes if retained on impervious layers within the construction, such as damp proof membranes (DPMs) and VCLs.









Floors may incorporate a heating system based on piped hot water or electrical elements. Systems based on piped hot water may be installed within a concrete slab or in a cement:sand screed; electrical elements may be installed within a concrete slab or in a cement:sand screed or be laid directly beneath the floor covering.

In order to avoid the risk of harmful condensation in floors, designers should follow the recommendations in F.3 and F.4.

For designs other than those in F.3 and F.4, designers should prepare a condensation risk analysis for each proposed floor construction, based on the properties and thicknesses of the materials to be used in their proposed design.

NOTE The figures in this annex use the following graphic conventions. Small gaps are shown between layers in the figures to distinguish one layer from another but in reality the layers would be in contact. Cavities are labelled as such.

Key to the figures

	applied finishes		thermal insulation (rigid) ^{A)}
	concrete		soil
	structural timber		AVCL
	thermal insulation (compressible) ^{B)}		membrane with low vapour resistance

^{A)} Will normally have high vapour resistivity.

^{B)} Will normally have low vapour resistivity.

F.2 Categories of floors

Floors of buildings may be categorized as:

- a) *groundbearing* floors of concrete which are cast on and supported by a prepared base; or
- b) *suspended* floors of structural concrete or timber with a void beneath them; such floors may separate a conditioned space from an unconditioned space, such as a loading bay, parking space, garage or void.

F.3 Groundbearing floors

On groundbearing floors there is a risk of surface condensation forming, particularly at the junction with external walls and at external corners; that risk may be eliminated by providing adequate heating and ventilation of the occupied space. In order to avoid thermal bridging, thermal insulation should be provided to the edges of the slab (see Annex J).

A damp proof membrane (DPM) should be provided in all groundbearing floors to protect against moisture from the ground. The DPM may be positioned depending on the moisture absorption properties of the insulant used.

Where the DPM is on the warm side of the insulation, it may also be assumed to form an AVCL. Where the DPM is on the cold side of the insulation, a separate AVCL should be placed on the warm side of any thermal insulation.

If thermal insulation is applied beneath the whole of the slab (Figure F.1) the floor may be regarded as a massive construction best suited to a continuous heating regime (see 4.5.2).

Figure F.1 **Groundbearing floor with insulation beneath the floor slab**

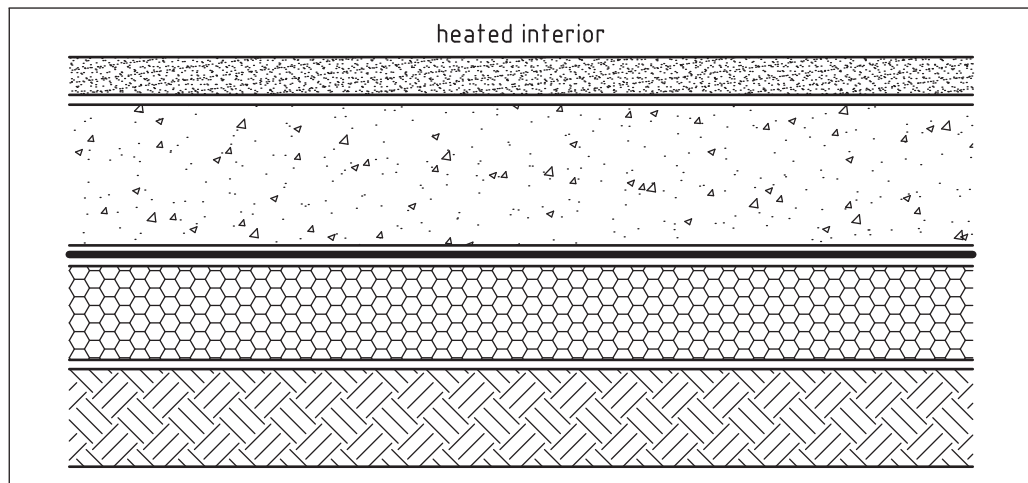

If thermal insulation is installed above the floor slab (Figure F.2) there is a risk of interstitial condensation occurring on the upper surface of the floor slab; to prevent that, an AVCL with a vapour resistance equivalent to that of the DPM should be laid over the thermal insulation. Such a floor may be regarded as suitable for intermittent heating regime (see 4.5.2).

Figure F.2 **Groundbearing floor with insulation above the floor slab**

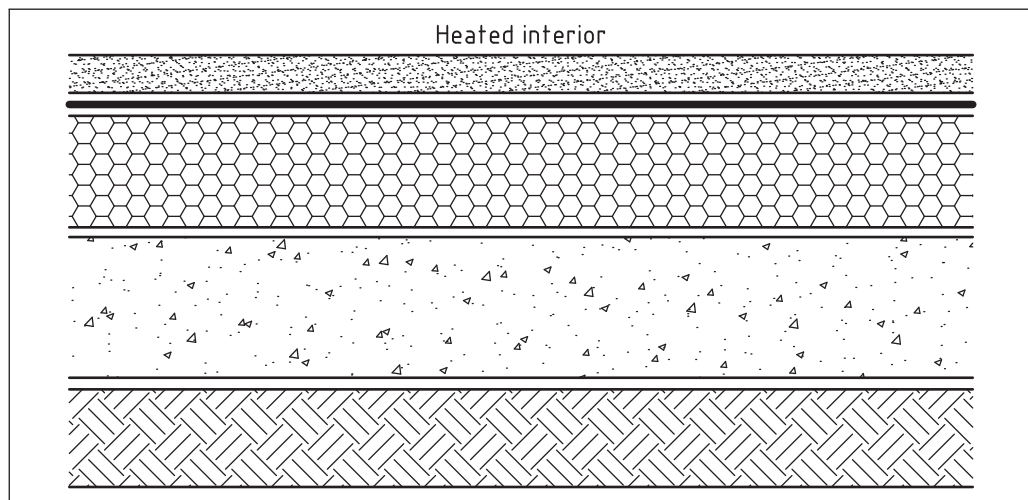

F.4 Suspended floors

F.4.1 General

A suspended floor may be formed of concrete cast in situ, or consist of pre-cast slabs or pre-cast beams with infill blocks or be formed with timber joists and boarding. A suspended floor which separates similarly conditioned spaces does not normally incorporate thermal insulation; in such floors there is no risk of surface or interstitial condensation.

A suspended floor which separates a conditioned space from an unconditioned space or void should incorporate thermal insulation. As the soffit of the floor will be at or near external air temperature there might be a risk of surface and/or interstitial condensation: such risk may be eliminated by providing adequate heating and ventilation of the conditioned space.

F.4.2 Suspended concrete floors

A suspended concrete floor may be insulated either above or beneath the concrete slab. When insulation is applied above the slab there is no risk of surface condensation but interstitial condensation is likely to occur on the upper surface of the slab; to avoid that risk an AVCL should be laid between the thermal insulation and the floor finish (Figure F.3) and the space beneath the floor should be ventilated. In the case of dwellings, subfloor ventilation should be provided by vents not less than 1 500 mm²/m run of external wall or 500 mm²/m² of floor area, whichever is the greater.

Such a floor may be regarded as suitable for an intermittent heating regime (see 4.5.2).

When thermal insulation is applied beneath the slab (Figure F.4) the floor may be regarded as suitable for use in continuously heated buildings; in such cases there is no likelihood of interstitial condensation; however, surface condensation can occur if continuous heating is not provided (see 4.4.6).

If an external soffit of high vapour resistance is provided, an AVCL should be installed on the warm side of the insulation and a ventilated void not less than 50 mm deep should be provided between the thermal insulation and the soffit.

Figure F.3 Suspended concrete floor with insulation above the floor slab

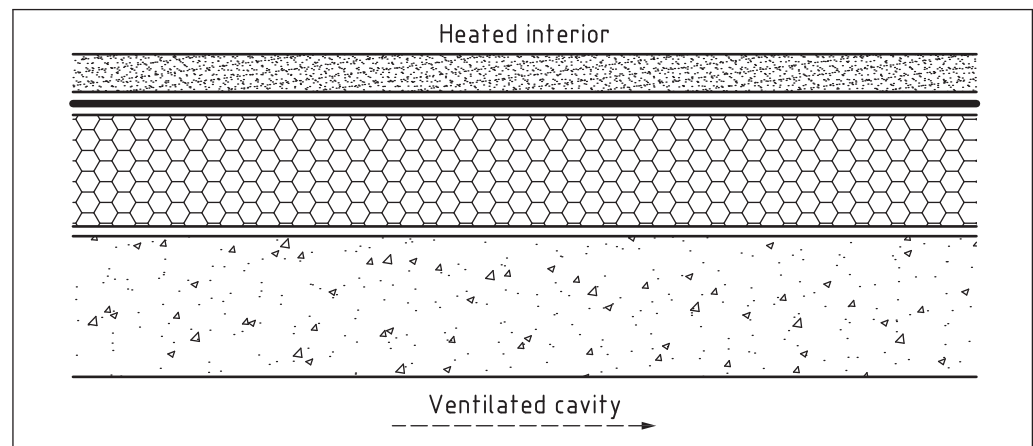
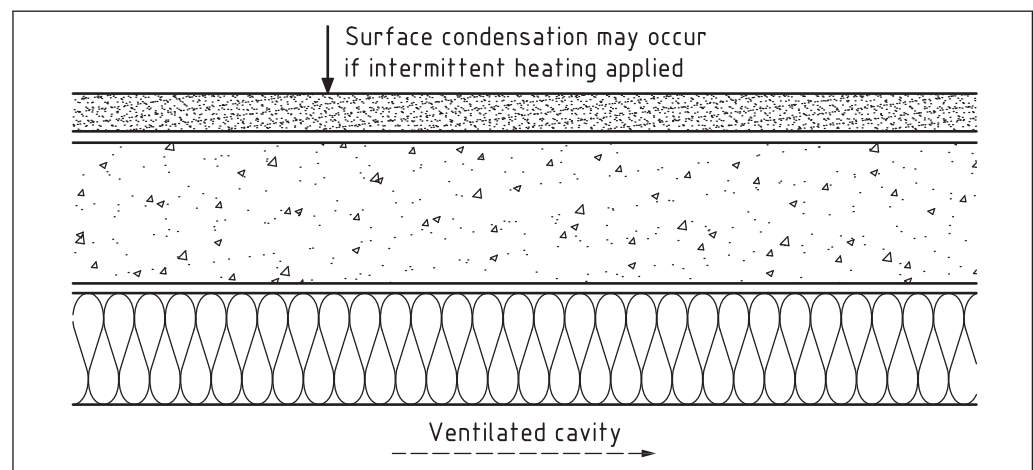

Figure F.4 Suspended concrete floor with insulation below the floor slab



F.4.3 Suspended timber floors

A suspended timber floor may be insulated by applying insulation above, between or beneath the joists, separately or in any combination of these three locations.

Voids below suspended timber ground floors should be ventilated. In the case of dwellings, ventilation may be achieved by means of vents not less than $1\,500\text{ mm}^2/\text{m}$ run of external wall or $500\text{ mm}^2/\text{m}^2$ of floor area whichever is the greater.

When thermal insulation is applied above the joists there is no risk of surface condensation but interstitial condensation can occur on the timber; to avoid such condensation an AVCL should be laid between the thermal insulation and the floor finish (Figure F.5).

When thermal insulation is applied between the joists (Figure F.6), it should not be supported on a material which offers a vapour resistance higher than that of the thermal insulation.

If an external soffit of high vapour resistance is provided, an AVCL should be installed on the warm side of the insulation and a ventilated void not less than 50 mm deep should be provided between the thermal insulation and the soffit.

Figure F.5 **Suspended timber floor with insulation above the joists**

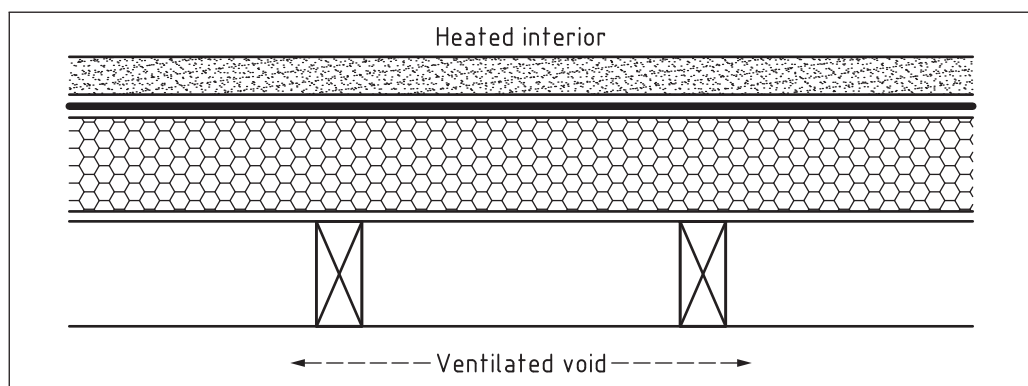

Figure F.6 **Suspended timber floor with insulation between the joists**

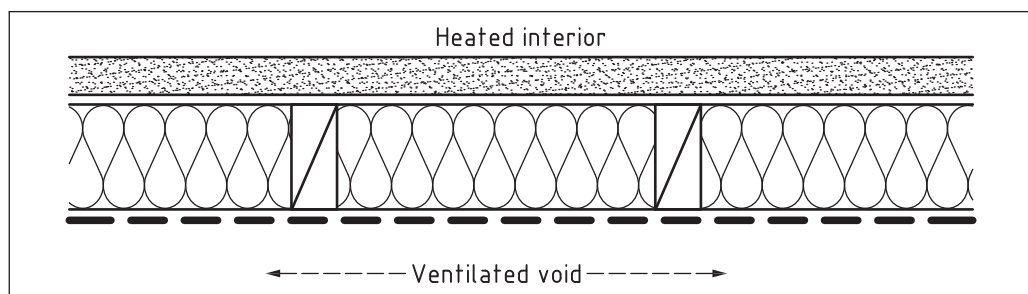
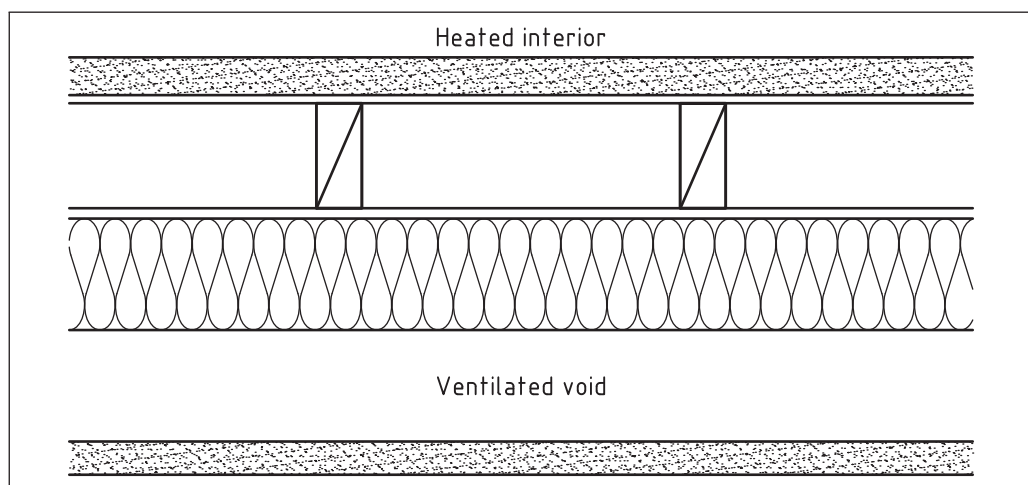

Figure F.7 **Timber suspended floor with a soffit of high vapour resistance**



Annex G
(normative)
G.1

Application of design principles – Walls

General









The designer should take account of and document the following sources of moisture in walls:

- ground moisture;
- rainwater;
- construction moisture; water incorporated in mortar, plaster and render released as the construction dries out; until the construction reaches its equilibrium moisture content, the theoretical thermal performance of the wall will not be achieved;
- moisture generated by the occupants and their activities which are liable to change during the life of the building.

In order to avoid the risk of harmful condensation in walls, designers should follow the recommendations on avoiding condensation in walls given in **G.2** to **G.7**. For all framed wall constructions and for those designs other than those in **G.2** to **G.7**, such as walls of cob, breathing walls and the walls of cold stores, designers should prepare a condensation risk analysis for each proposed wall construction, using the properties and thicknesses of the materials specific to their proposed design.

NOTE Figures in this annex use the following graphic conventions. Small gaps between layers are shown in the figures to distinguish one layer from another. In reality the layers are in contact. Cavities are labelled as such.

Key to the figures

	internal surface finish		thermal insulation (rigid) ^{A)}
	masonry		external surface finish
	structural timber		AVCL
	sheathing		membrane with low vapour resistance
	thermal insulation (compressible) ^{B)}		

^{A)} Will normally have high vapour resistivity.

^{B)} Will normally have low vapour resistivity.

COMMENTARY ON G.1

The risk of surface condensation depends on the mass of the construction and the position of thermal insulation in relation to that mass. In a constantly heated building with continuous thermal insulation and no thermal bridging at junctions, or around any openings and service penetrations, there is minimal risk of surface condensation. In the case of a building with high mass and intermittent heating, where the thermal mass is not isolated from the heated space, the risk is increased.

The risk of interstitial condensation in a wall depends upon:

- a) *the amount of water vapour generated within the building (see Annex C);*
- b) *the vapour resistance and air permeability of any internal finish;*
- c) *the location of the thermal insulation relative to other materials and voids;*
- d) *the vapour resistance and thermal conductivity of the thermal insulation;*
- e) *the vapour resistance and air permeability of the external covering;*
- f) *the position of any AVCL.*

A cavity between the AVCL and the internal lining, in which services can be run, will eliminate the need for penetrations of the AVCL.

G.2 Categories of walls

The majority of walls of buildings may be categorized as:

- a) *masonry*, consisting of brickwork, blockwork, concrete with insulated formwork or poured concrete; such walls may incorporate a cavity;
- b) *framed* constructions of timber, concrete or metal, with an external finish such as masonry, tile hanging, render or boarding;
- c) *cladding systems*, such as glazing, curtain walling or insulated metal panels, supported on structural framing members;
- d) *structural insulated panel systems (SIPS)* which are self-supporting.

G.3 Masonry walls

G.3.1 Solid masonry

G.3.1.1 General

Solid masonry walls may consist of stonework, brickwork, blockwork or concrete: because of their thermal mass they respond slowly to changes in air temperature and, being hygroscopic, they will absorb moisture to some degree. If a masonry wall has external finish or cladding, designers should take account of such finish or cladding when assessing thermal performance and the risk of condensation.

Moisture within a wall will reduce its thermal resistance and increase the risk of both surface and interstitial condensation. In order to achieve the level of thermal performance required of a heated building, solid masonry may be insulated by applying thermal insulation either externally or internally.

To avoid thermal bridging, the insulation, together with any finish and AVCL, should be returned into the reveals of any openings. Particular attention should be paid to wall/roof and wall/floor junctions (see Annex J).

G.3.1.2 Solid masonry wall – External insulation and protective finish with low vapour resistance finish

An external thermal insulation system, incorporating thermal insulation and a low resistance protective finish, such as a render or ventilated cladding, may be applied to new or existing walls; such systems are best suited to buildings which are heated continuously. If such systems are applied to buildings which are heated only intermittently, there is a risk of condensation occurring on the internal surface of the wall, and a condensation risk analysis should be carried out to determine whether an AVCL is required.

The insulation, together with its finish, can help to reduce thermal bridging at junctions and reduce the risk of rainwater penetration.

Externally applied thermal insulation may be used that incorporates a separate protective finish or that is used in conjunction with a separate protective cladding.

Dependent upon the thickness and composition of the wall, the insulant and the protective layer, there is a risk of interstitial condensation and a condensation risk analysis should be performed to determine whether an internal AVCL is needed (Figure G.1).

Figure G.1 **Solid masonry wall – External insulation and protective finish with low vapour resistance**

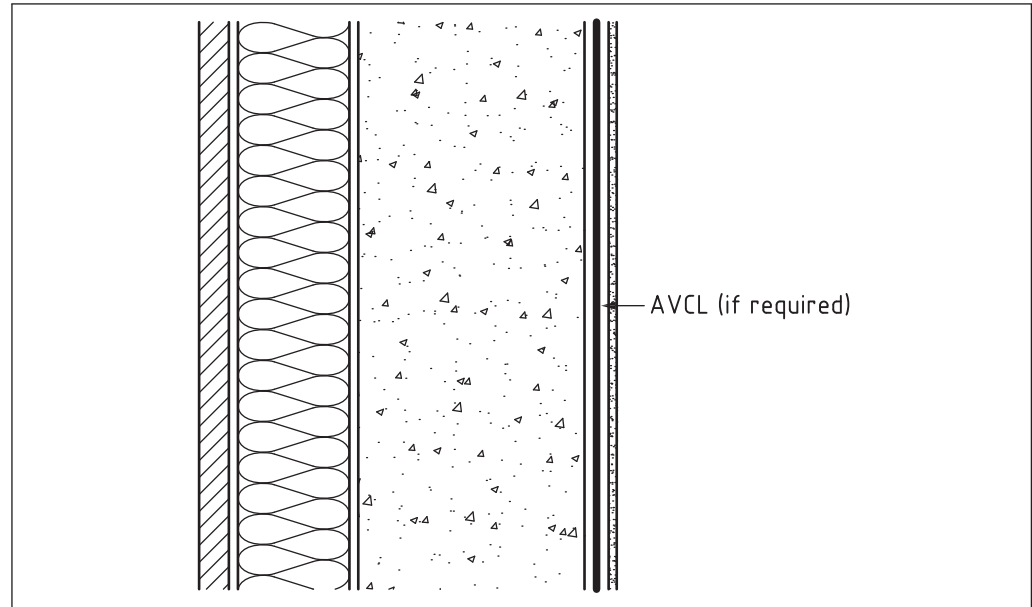

G.3.1.3 **Solid masonry wall – External insulation with high vapour resistance**

If the external finish has a higher vapour resistance than the internal lining/finish, a ventilated cavity should be formed between the finish and the insulation (Figure G.2) and an AVCL should be provided on the warm side of the insulation.

Figure G.2 **Solid masonry wall – External insulation with high vapour resistance**

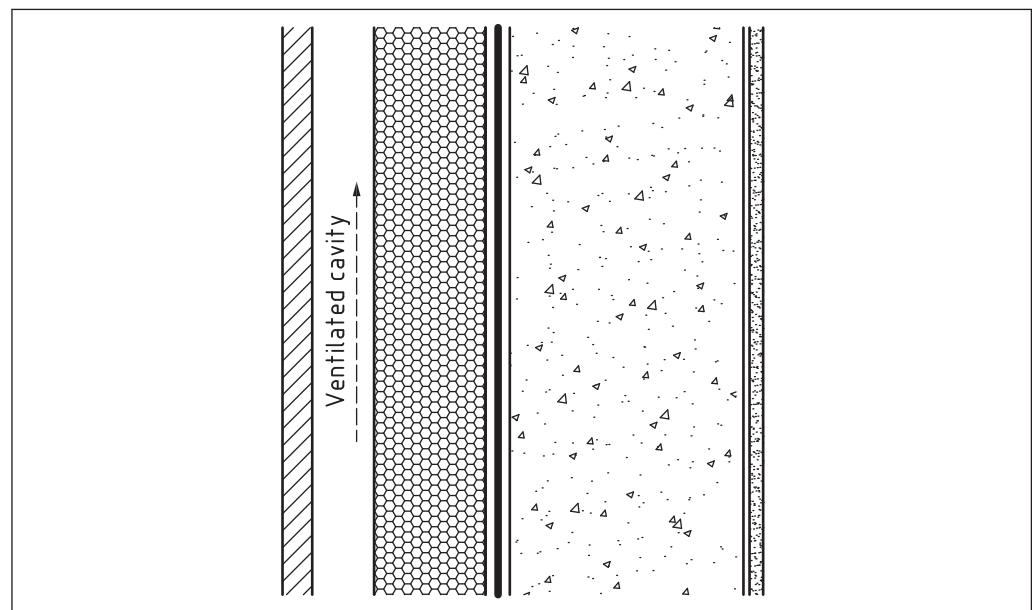

G.3.1.4 **Solid masonry wall – Internal insulation**

Solid masonry walls, insulated internally may be used with an intermittent heating regime without incurring a risk of surface condensation.

Internally applied thermal insulation isolates the heated interior from the masonry, which will therefore be cold, producing a risk of interstitial condensation behind the thermal insulation; to prevent that, an AVCL should be applied on the warm side of the thermal insulation (Figure G.3).

Figure G.3 **Solid masonry wall – Internal insulation**

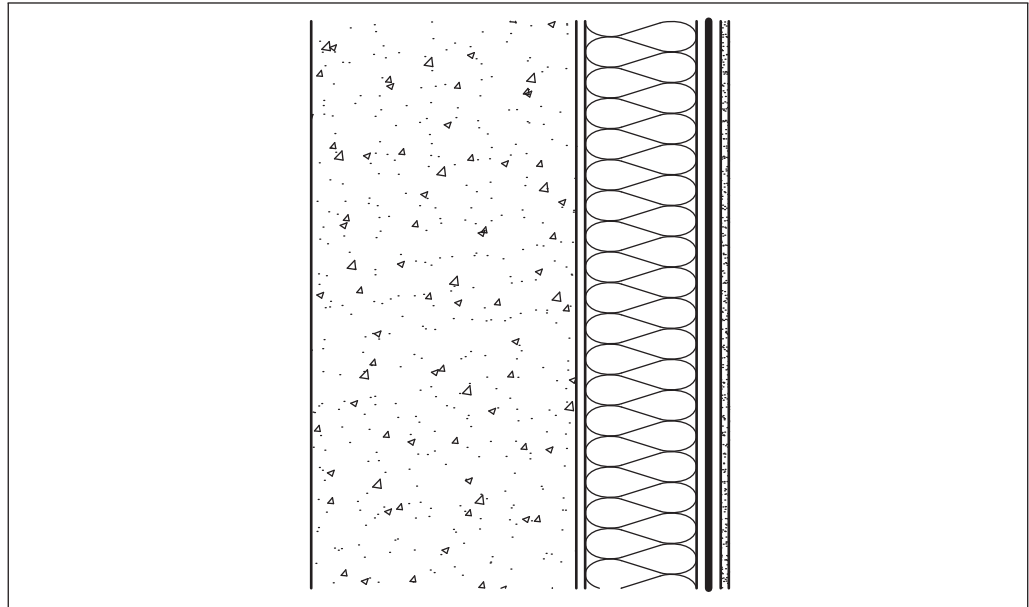

G.3.2 **Masonry wall with cavity**

G.3.2.1 **General**

Masonry walls of stonework, brickwork, blockwork or concrete may incorporate a cavity, the primary function of which is to prevent the transmission of rainwater to the interior. Rainwater might well penetrate the external skin of masonry, reducing its thermal resistance, and provision should be made for such moisture to drain out of the cavity: open perpend provided for this purpose also act as vents, which might affect the thermal resistance of the wall (see Annex E). In order to achieve the required level of thermal performance, masonry walls with a cavity may be insulated by applying thermal insulation externally, within the cavity or internally.

G.3.2.2 **Masonry wall with cavity – External insulation**

The application of thermal insulation to the outside of a masonry wall incorporating a cavity (Figure G.4) should follow the recommendations of G.3.1.2. This form of construction may be considered particularly suitable for upgrading the thermal performance of existing masonry walls which incorporate a cavity. However, if the building is heated intermittently there is a risk of surface condensation.

Figure G.4 Masonry wall with cavity – External insulation

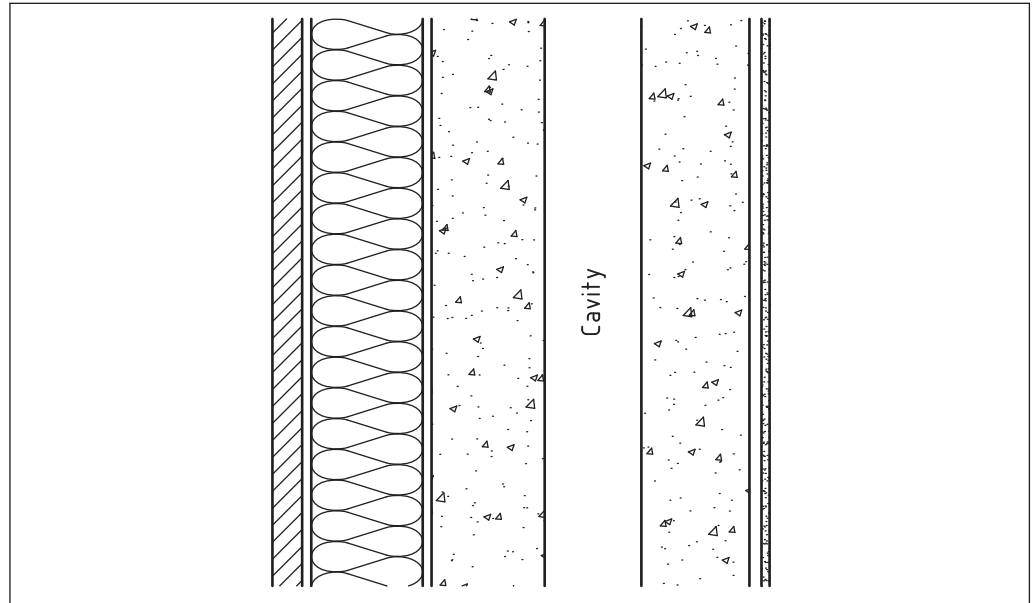

G.3.2.3 Masonry wall with cavity – Insulation within the cavity

A wall cavity may be partially or completely filled with thermal insulation (Figure G.5 and Figure G.6).

COMMENTARY ON G.3.2.3

Applying thermal insulation within a wall cavity risks compromising the primary function of the cavity, namely the avoidance of rainwater penetration. Detailed information on the driving rain loads likely to arise in different situations and designs can be found in BS 8104, which allows the identification of the relevant exposure zone(s). Guidance on the avoidance of rainwater penetration for a given exposure zone can be found in PD 6697.

The risk of surface condensation depends on the heating regime and the thermal mass of the inner leaf, the greatest risk occurring when a high density inner leaf construction is combined with an intermittent heating regime. Any interstitial condensation which might occur will do so on the inner surface of the external skin, where it is unlikely to cause damage to non-hygroscopic insulation, or insulation which does not fill the cavity.

Figure G.5 Masonry wall with cavity – Insulation partially filling the cavity

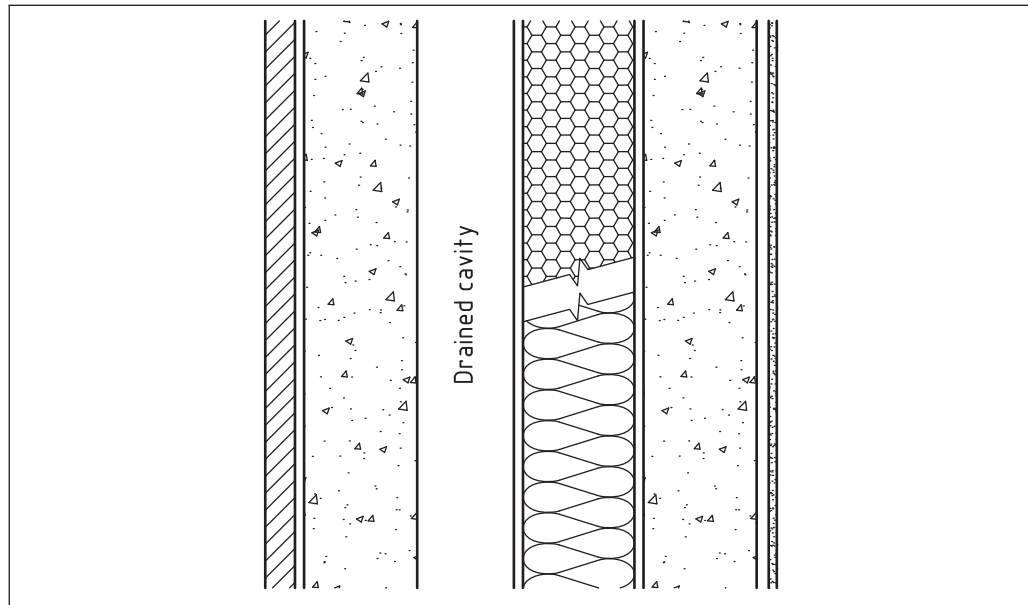
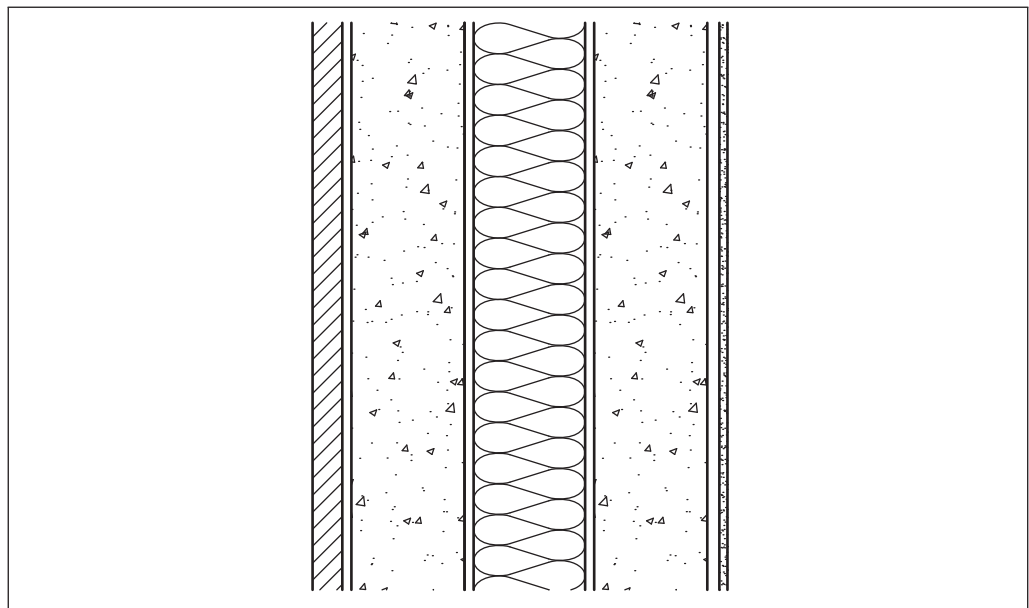

Figure G.6 Masonry wall with cavity – Insulation filling the cavity



G.3.2.4 Masonry wall with cavity – Internal insulation

The primary functions of the cavity and the external skin are unaffected when thermal insulation is applied to the inside surface of a masonry wall with a cavity: such walls may be used with an intermittent heating regime without incurring a risk of surface condensation.

Internally applied thermal insulation isolates the heated interior from the masonry which will therefore be cold, producing a risk of interstitial condensation behind the thermal insulation. To prevent that, an AVCL should be applied between the thermal insulation and the internal finish (Figure G.7).

Figure G.7 Masonry wall with cavity – Internal insulation

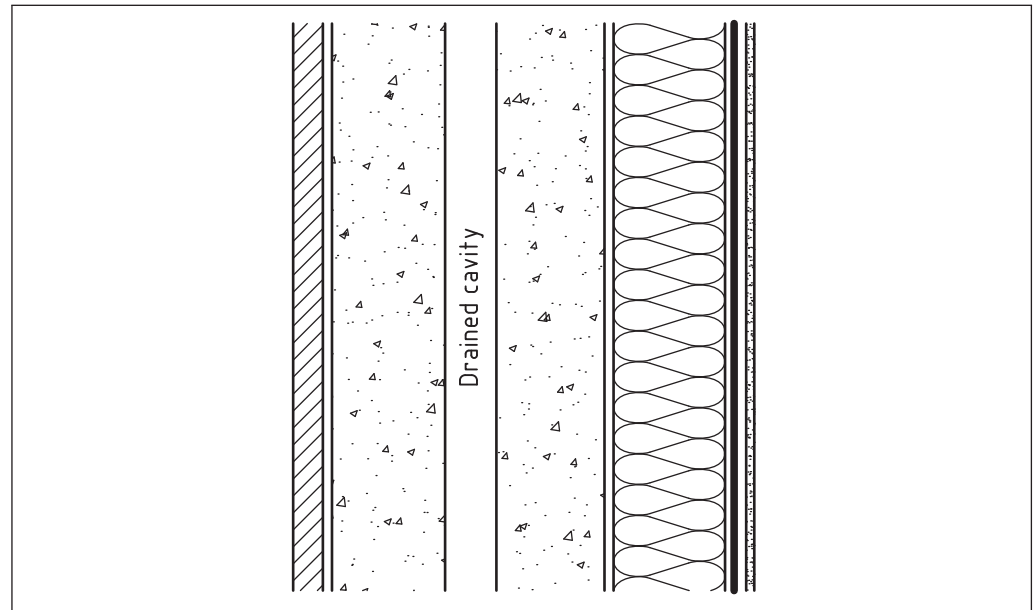

G.3.3 Masonry wall of concrete with insulating formwork (ICF)

Loadbearing external walls may be formed with concrete poured into hollow interlocking blocks of thermal insulation to which various external and internal surface finishes may be applied (Figure G.8); there is little risk of internal surface condensation with this form of construction.

It is particularly important to undertake condensation risk analysis for this form of construction: there is a risk of interstitial condensation occurring if:

- a) asymmetrical formwork is installed with the thinner layer of insulation to the outside of the concrete core; and/or
- b) the vapour resistance of any externally applied finish is greater than that of any internally applied finish.

If an impermeable external finish is applied it is essential to provide a ventilated cavity between that finish and the formwork.

Figure G.8 Masonry wall – Concrete with insulating formwork

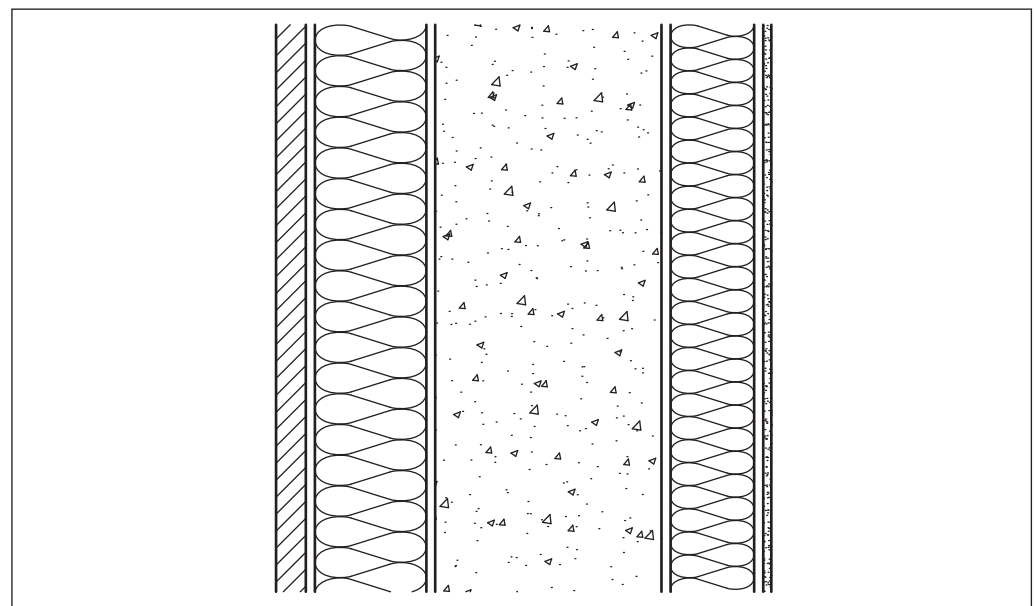

G.4 Framed walls

G.4.1 General

COMMENTARY ON G.4.1

To provide resistance and structural rigidity, framed walls which consist of timber studwork usually have sheathing, and metal studwork usually has strapping. An internal finish such as plasterboard, and an external finish or cladding, such as brickwork, render system, tile hanging or timber boarding usually forms a weatherproofing layer. Such walls are generally considered to be lightweight constructions with relatively low thermal mass.

There is little risk of internal surface condensation occurring with timber framed walls. However, with metal framed walls, there is a likelihood of localized surface condensation, as a result of thermal bridging if insulation is provided only between the framing members.

Thermal insulation may be applied between and/or to one or to both sides of the framing members. Due to the effects of thermal bridging, it should be borne in mind that it might be difficult to obtain the required level of thermal performance by insulating solely between the framing members, particularly with metal framing.

In framed walls there is a risk of interstitial condensation occurring behind impermeable external finishes or cladding: to avoid that a vented space should be provided immediately behind the finish or cladding.

There is also a risk of interstitial condensation occurring on the inner surface of any sheathing applied directly to the outside of the framing: to avoid that, an AVCL, with a vapour resistance of at least double that of the sheathing, should be provided on the warm side of the insulation, behind the internal surface finish. A void behind the internal surface finish provided to enable services to be installed may be used to avoid compromise to the AVCL.

By careful balancing of the vapour resistances of internal and external layers, the risk of interstitial condensation may be avoided.

NOTE If the above recommendations are followed, the risk of decay of timber framing will be minimized. Nevertheless, for practical reasons, it might be advisable to increase the durability of structural timber by preservative treatment.

G.4.2 Framed wall – External insulation

Externally applied thermal insulation may be used to ensure the structural framing is maintained at or near the internal temperature of the building so avoiding the risk of localized internal surface condensation (Figure G.9).

Figure G.9 Framed wall – External insulation

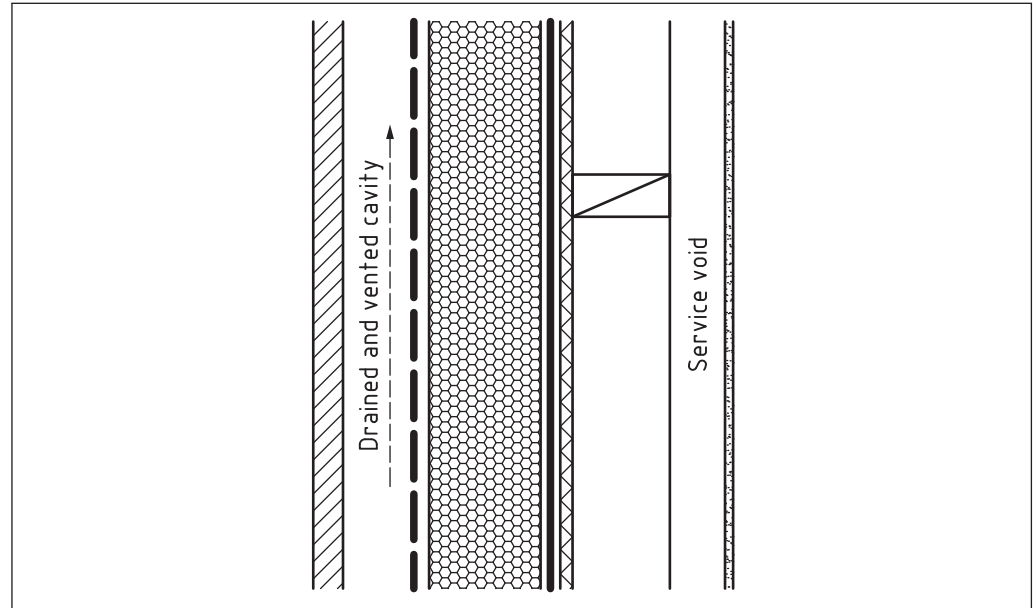

G.4.3 Framed wall – Insulation between framing members

Framed walls may be insulated by fitting thermal insulation to fill the voids between framing members. It is essential that the insulation is fitted accurately with no gaps between it and the framing members and the insulation; both gaps and framing members form thermal bridges through the insulating material with a consequent risk of localized surface condensation.

There is a risk of interstitial condensation if sheathing fixed to the outer face of the structural framing offers greater vapour resistance than that of the internal finishes: to avoid that, an AVCL with a vapour resistance of at least double that of the sheathing should be provided on the warm side of the insulation (Figure G.10).

Figure G.10 Framed wall – Insulation between framing members

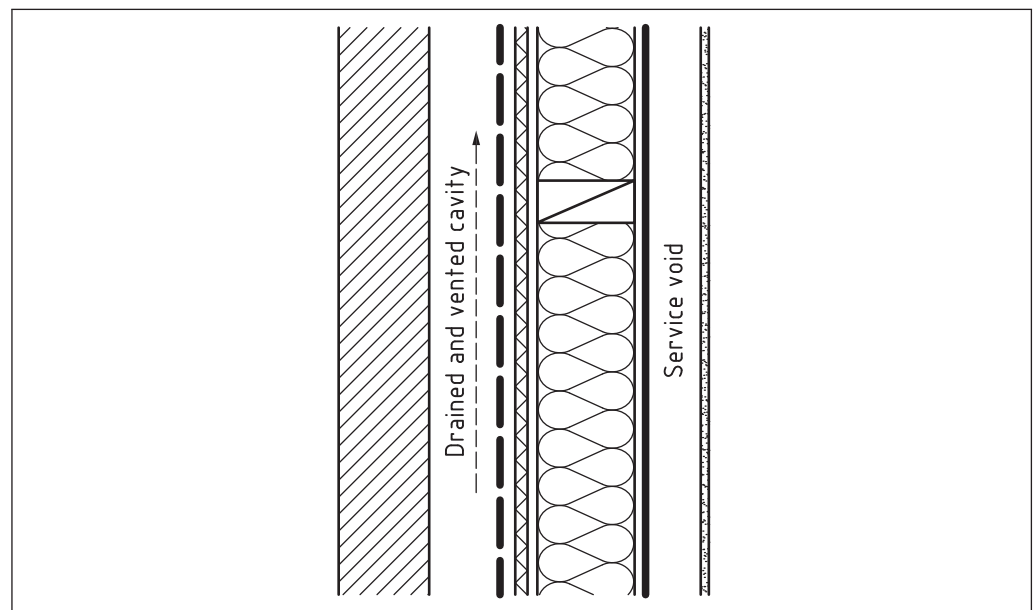

G.4.4 Framed wall – Internal insulation

Internally applied thermal insulation may be used to ensure the internal finish is maintained at or near the internal temperature of the building and avoid the risk of internal surface condensation.

Because the structural framing will be close to external temperature there is a high risk of interstitial condensation: to avoid that risk, an internal VCL with a vapour resistance greater than that of externally applied sheathing and/or external cladding should be applied behind the internal surface finish (Figure G.11).

Figure G.11 Framed wall – Internal insulation

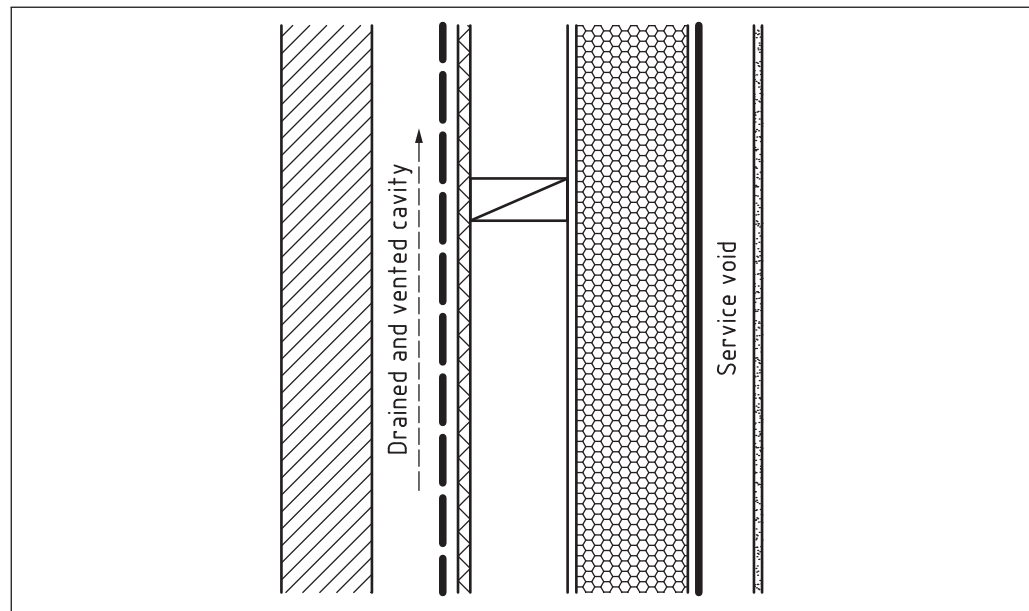

G.4.5 Framed wall – Thermal insulation between and across framing members

G.4.5.1 General

In order to obtain a required level of thermal performance, including the avoidance of thermal bridging, rigid thermal insulation may be applied to one face of the structural framing in combination with insulation in the voids between framing members. Such rigid thermal insulation may be applied to either face of the frame; it does not take the place of structural sheathing; with this form of construction there is no risk of internal surface condensation.

Depending upon the relative positions and vapour resistance values of the sheathing and thermal insulation there might be a risk of interstitial condensation: it is imperative designers undertake condensation risk analysis of these composite constructions.

Vented air spaces should have openings to the outside air of not less than 500 mm²/metre length of wall. Where cavities are not continuous but occur between cavity barriers, each individual cavity should be vented. Care should be taken to prevent the ingress of large insects, small mammals or birds and to avoid rainwater penetration. To avoid excessive resistance to airflow a nominal mesh/grill size of 4 mm is recommended.

G.4.5.2 Framed wall – Thermal insulation between and to the outside of structural framing

If rigid thermal insulation is applied to the external face of the framing, the risk of interstitial condensation occurring depends upon the relative thicknesses, thermal resistances and vapour resistances of the two types of insulation; for such constructions, it is essential that a condensation risk assessment be carried out. An AVCL should be provided on the warm side of the insulation (Figure G.12).

Figure G.12 Framed wall – External sheathing – Thermal insulation between the framing and on the outside of the sheathing

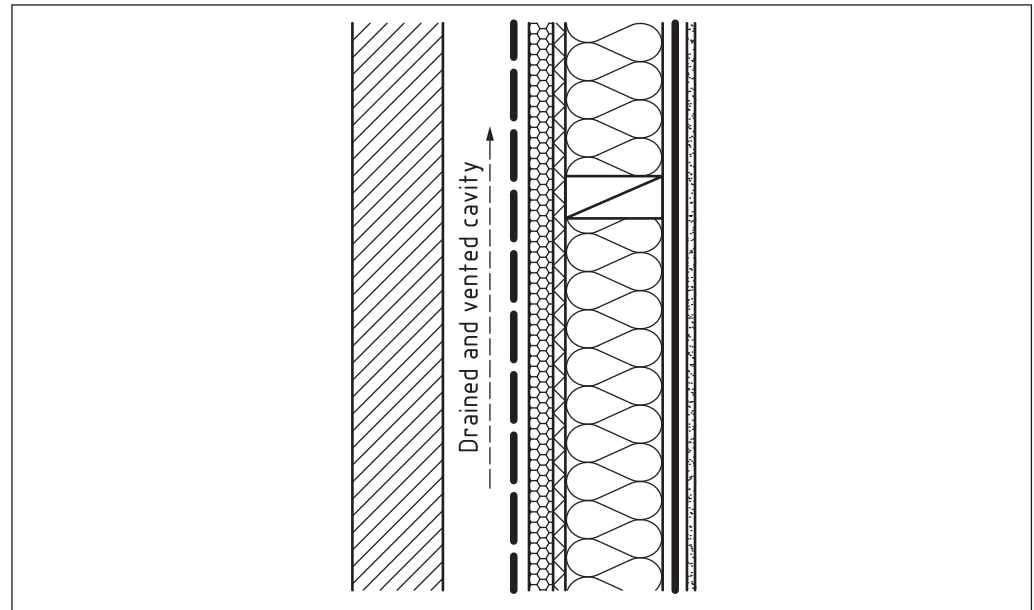

G.4.5.3 Framed wall – Internal sheathing – Thermal insulation between the framing and on the inside of structural sheathing

If rigid thermal insulation is applied to the inner face of a frame with sheathing on the outside, there is a risk of interstitial condensation; the risk depends upon the relative thicknesses and thermal resistances of the layers of insulation. An AVCL should be provided on the warm side of the insulation (Figure G.13).

If rigid thermal insulation is applied to the internal face of the framing the risk of interstitial condensation occurring depends upon the relative thicknesses and thermal resistances of the two types of insulation; for such constructions it is essential that a condensation risk assessment be carried out. An AVCL should be provided on the warm side of the insulation (Figure G.14).

Figure G.13 Framed wall – External sheathing – Thermal insulation between on the inside of the framing

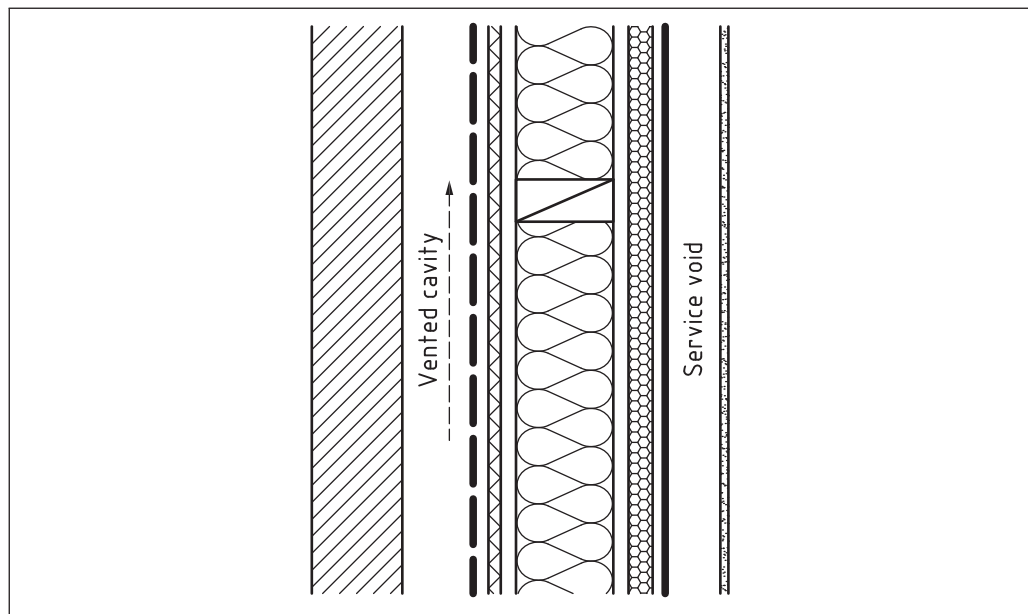
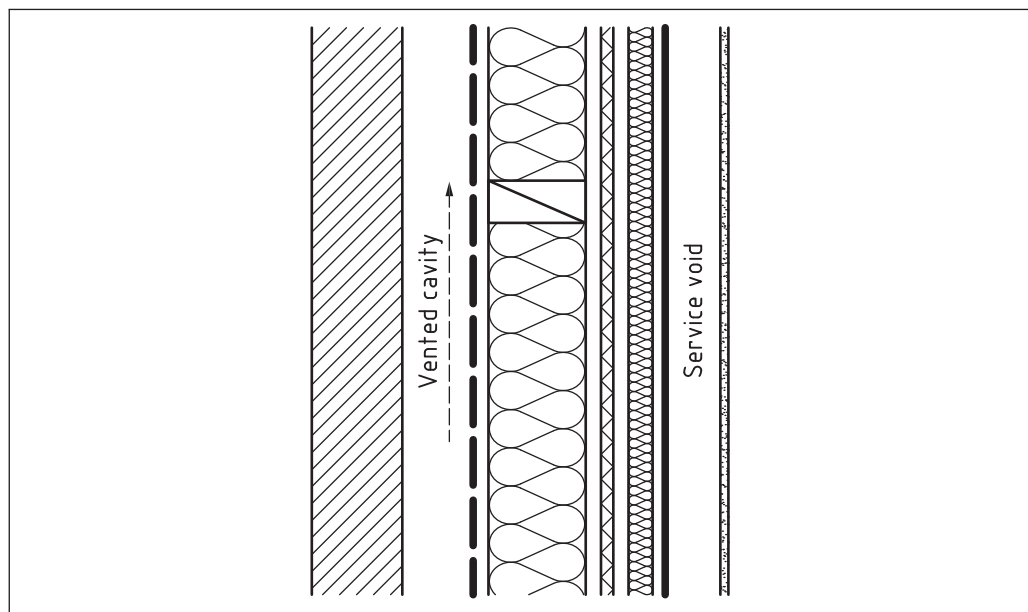

Figure G.14 Framed wall – Internal sheathing – Thermal insulation between and to the inside of the structural framing



G.5 Cladding systems

G.5.1 General

For guidance on cladding systems designers should refer to BS 5427 and MCRMA Technical papers 17 [7] and 18 [8], BS 8298 for stone cladding, BS 8297 and BS EN 490 for concrete cladding.

G.5.2 Cladding systems – Composite insulated panels

Framed cladding panels with vapour permeable internal and external finishes will have the same condensation risk as the comparable framed wall construction; designers should observe the guidance in G.4 and pay particular attention to the formation of a continuous AVCL at panel junctions.

In order to avoid the risk of interstitial condensation end and side laps should be sealed to prevent moisture reaching the panel interior: panel fixings should not significantly compromise the vapour resistance of the internal lining.

COMMENTARY ON G.5.2

Factory-formed, metal-faced, insulated cladding panels do not give rise to surface condensation as the integral thermal insulation maintains the inner face of the panel close to room temperature (Figure G.15).

The impermeable metal internal lining prevents water vapour diffusing into the interior of the panel, eliminating any risk of interstitial condensation. However, water vapour diffusion is still possible at panel edges.

Figure G.15 Cladding systems – Integral thermal insulation – Prefabricated

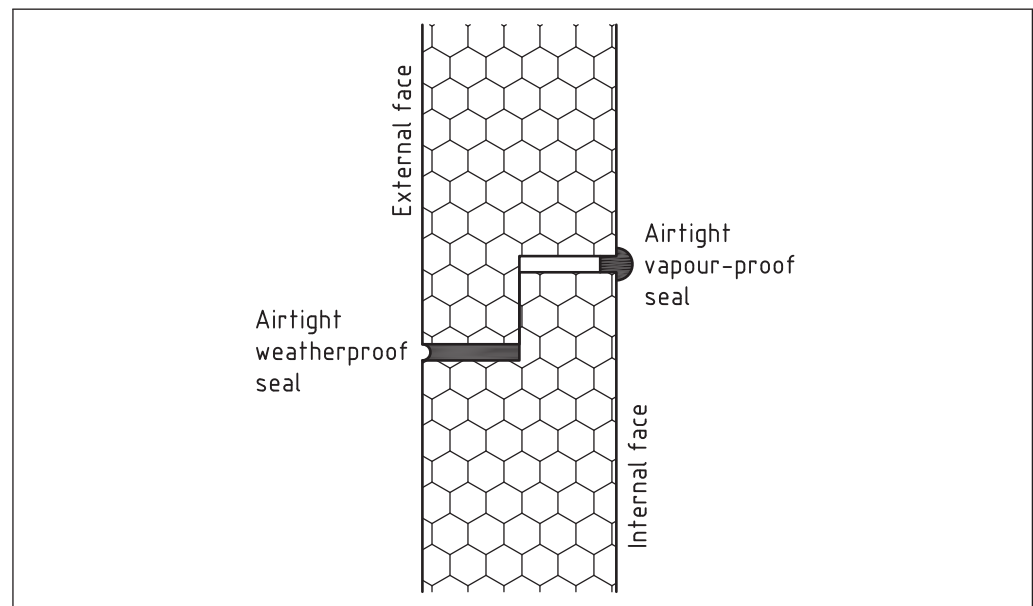

G.5.3 Cladding systems – Built in situ

NOTE Cladding formed on site from profiled metal sheets, thermal insulation and internal lining, does not present a risk of surface condensation, as the internal lining is maintained close to the building's internal temperature.

In order to prevent interstitial condensation forming within the panel, an AVCL should be provided on the warm side of the insulation. If the internal lining panels have a vapour resistance equal to or greater than that of the external sheeting they will form an effective AVCL provided all joints between panels are fully sealed. Otherwise, an AVCL should be provided (Figure G.16).

Figure G.16 Cladding systems – Integral thermal insulation – Built in situ

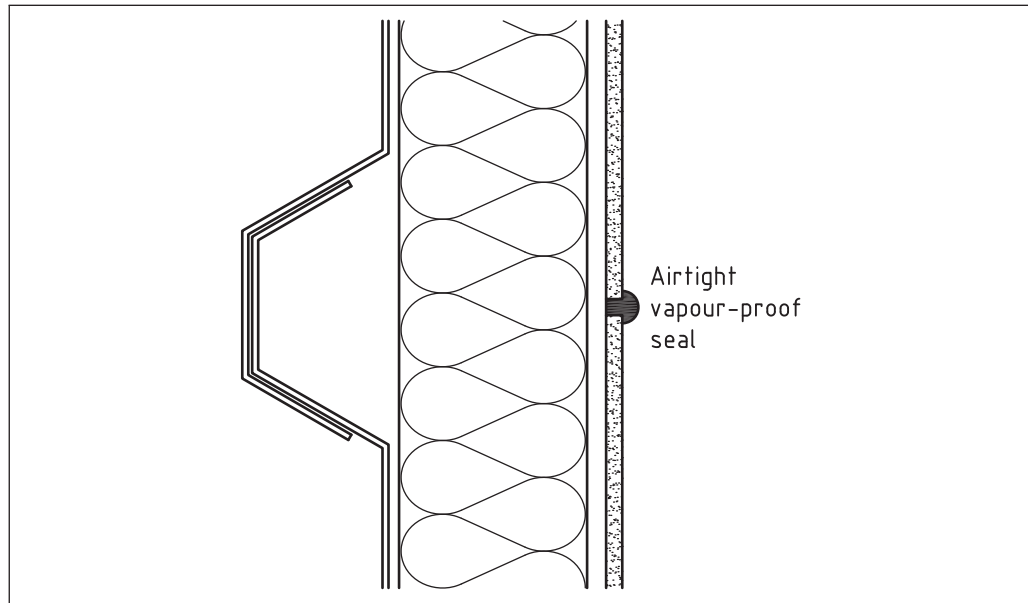

G.5.4 Cladding systems – Rainscreen cladding

NOTE Rainscreen cladding systems partially protect walls from UV and wind-driven rain; they commonly have air-open joints and a ventilated void immediately behind cladding panels. Such systems do not have any risk of interstitial condensation.

The wall structure should be protected by means of a UV durable breather membrane as described in BS EN 13859-2.

G.6 Structural insulated panel systems (SIPS)

Factory assembled panels made by bonding a core of rigid foam plastic insulation between two structural skins (SIPS) may be used in walls or roofs, may be lined on the inside with plasterboard, and may be clad on the outside with masonry, metal or timber. The risk of interstitial condensation occurring in such construction depends upon the relative positions and vapour resistance values of the various materials used to construct the panels.

It is essential that a condensation risk analysis is carried out. An AVCL should be provided on the inner face of the panel system (Figure G.17).

Figure G.17 Structural insulated panel

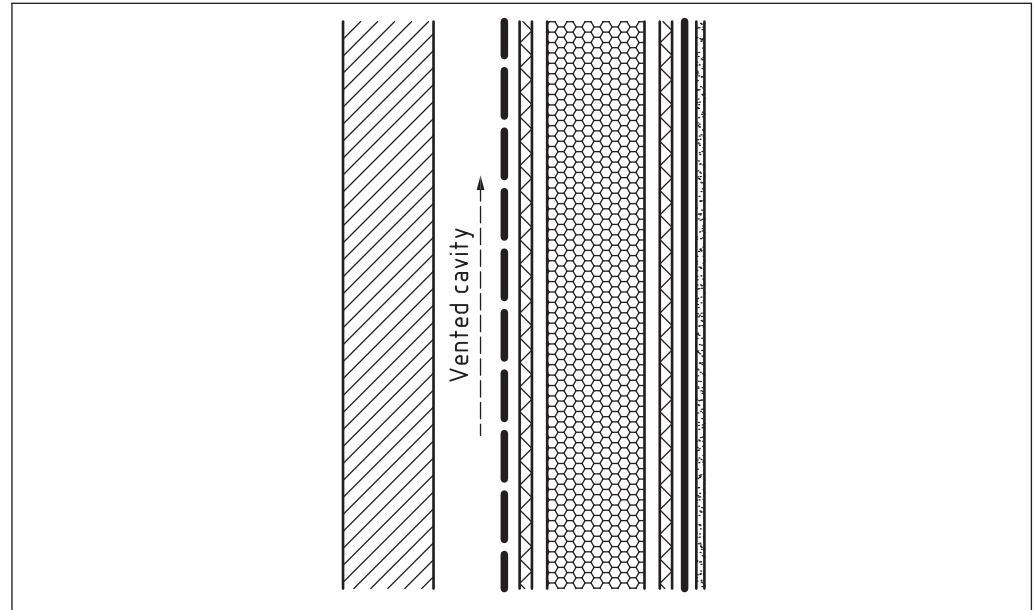

G.7 Openings in walls

External walls necessarily incorporate openings to accommodate components such as windows and doors and can also be penetrated by pipes and services such as extract fans. There is a risk of interstitial condensation as a result of air leakage at openings and services; to avoid that occurring, any AVCL should be sealed to the perimeter of the component or service penetration (see Annex J).

If double windows are installed, the inner component should be as airtight as possible and trickle ventilation should be provided from the space between the windows to outside air. For information and guidance on background ventilation (see Annex K).

NOTE The thermal transmittance of components is invariably greater than that of the walls in which they are incorporated, whilst, at the same time, those components are effectively impermeable: as a result there is an increased risk of surface condensation occurring on the components.

In order to avoid the risk of surface condensation, the thermal transmittance value of all components in external walls should be sufficiently low to maintain their inner surface close to internal temperature of the building. Frames should be made of low thermal transmittance material, or incorporate a thermal break; door leaves and windows should be insulated. All glazing in doors and windows should be manufactured with insulating glass units (IGUs) in accordance with BS EN 1279 (all parts).

Annex H (normative) H.1

Application of design principles – Roofs

General

NOTE For the purposes of this standard a roof is deemed to incorporate all the construction which separates the external environment from the internal occupied space.

The designer should take account of and document the following sources of moisture:

- a) water incorporated during the construction process (including precipitation);
- b) precipitation after construction;















- c) water vapour arising from the occupants and their activities;
- d) atmospheric moisture, drawn into the roof during warm humid weather conditions.

In order to avoid the risk of harmful condensation in roofs, designers should follow the recommendations given in **H.2** to **H.13**.

For designs other than those in **H.2** to **H.13**, designers should prepare a condensation risk analysis for each proposed roof construction, using the properties and thicknesses of the materials specific to their proposed design. Condensation risk analysis in warm pitched and flat roofs should be undertaken in accordance with **D.3**; guidance on condensation risk analysis in cold pitched roofs is given in **D.4**.

NOTE The figures in this annex use the following graphic conventions. Small gaps are shown between layers in the figures to distinguish one layer from another but in reality the layers would be in contact. Cavities are labelled as such.

Key to the figures

	internal surface finishes		low vapour resistance membrane
	air/vapour control layer (AVCL)		impermeable flat-roof covering
	concrete slab		load-bearing structure (rafters)
	structural framing (joists)		ventilated space
	impermeable external covering (pitched roof)		discontinuous external covering (pitched roof)
	protective layer		thermal insulation (compressible) ^{A)}
	timber boarding or sarking		thermal insulation (rigid) ^{B)}

^{A)} Will normally have low vapour resistivity.

^{B)} Will normally have high vapour resistivity.

H.2 Categories of roofs

The roof of any building may be pitched, flat or curved. It should be weatherproof, and in order to comply with regulations on energy conservation, the roof of a heated building has to incorporate thermal insulation.

Pitched roofs are defined by BS 5534 as having a slope greater than 10° but not more than 75°; they may have external coverings which are air permeable (allowing the passage of air) or air impermeable according to the materials used. For example:

- small discontinuous units, such as natural slates or tiles, which form a water-shedding covering which is air permeable, normally laid over an

underlay, which may be draped or fully supported on sheathing, on sarking boards, or rigid insulation and the combined covering might therefore be air impermeable;

- large discontinuous sheets of metal or fibre-reinforced cement, which are air impermeable but which have laps and joints which might be air permeable;
- a continuous, fully supported, waterproof covering, which is air impermeable.

Thermal insulation incorporated in a pitched roof may be located:

- on a horizontal ceiling, leaving an unheated loft or attic [termed a “cold pitched roof”, Figure H.1a)];
- at the rafter line: between, beneath or above the sloping roof structure, or a combination of those [termed a “warm pitched roof”, Figure H.1b)];
- partly on a horizontal ceiling and partly at the rafter line [termed a “hybrid pitched roof”, Figure H.1c)]; or
- within pre-fabricated structural insulated panels [Figure H.1d)].

The structure of a pitched roof may incorporate features such as valleys, hips and gables and may enclose occupied spaces. The external covering may be interrupted by dormers, roof windows, vents and chimneys, or fire break walls.

Flat roofs, defined by BS 6229 as having a slope of 10° or less, may be formed with dense structure (reinforced concrete) or with structural framing supporting a deck. The external covering may consist of a fully supported, continuous impermeable layer, such as a single-ply polymeric membrane, or of fully supported sheet metal, such as zinc or lead, with standing seams, or of self-supporting sheets or panels with sealed laps and joints. All flat roof coverings should be watertight and for the purposes of this standard should be regarded as impermeable.

Thermal insulation in a flat roof may be placed:

- a) beneath the roof deck, thus leaving the deck colder than the internal occupied space [termed a “cold flat roof”, Figure H.1e)];
- b) above the roof deck but beneath the waterproof covering, thus maintaining the temperature of the deck close to that of the internal occupied space [termed a “warm flat roof”, Figure H.1f)]; or
- c) above the waterproof covering, but beneath a protective layer such as screed or soil or pebbles laid over a filtration layer [termed a “inverted flat roof”, Figure H.1g)].

Curved roofs may contain both flat and pitched surfaces.

Figure H.1 Roofs categorized by position of the insulation

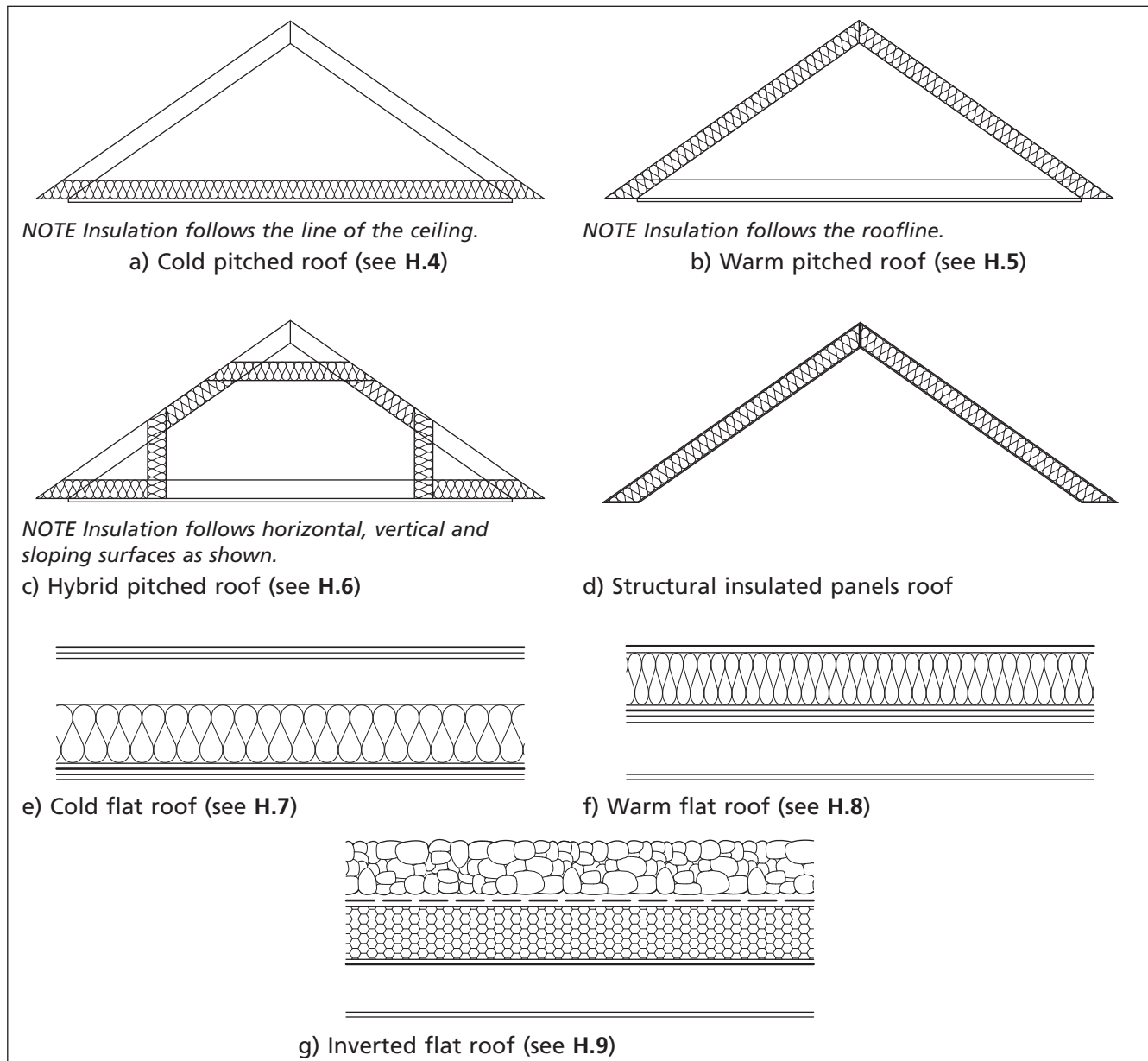

H.3 Design considerations

H.3.1 General

To minimize the risk of surface condensation on the ceiling of the occupied space, thermal insulation should be continuous and thermal bridging at roof/wall junctions and around any openings and service penetrations should be minimized.

The designer should take account of the risk of interstitial condensation in a roof, which depends upon:

- the amount of water vapour generated within the building (see Annex E);
- the vapour resistance and air permeability of any AVCL, ceiling or internal finish;
- the location of the thermal insulation relative to other materials and voids;
- the presence of voids within the roof and whether or not they are connected to atmosphere;

- e) the vapour resistance and thermal conductivity of the thermal insulation;
- f) the permeability of any underlay including any sarking;
- g) the permeability of the external covering.

In order to avoid interstitial condensation in any roof, it is essential to minimize the amount of moisture entering the roof. This may be achieved by removing excess moisture from the occupied spaces (see 5.2 and Annex N), and restricting the transfer of internal air into the roof. Building physics indicates that materials with the highest vapour resistance should be placed on the warm side of the thermal insulation and those with the lowest vapour resistance should be placed on the cold side of the thermal insulation. Provision should then be made for the safe dispersal to atmosphere of any moisture which might occur within the roof. Where insulation is built up in more than one layer of the same material, the thinner layer should be located on the warm side; where a combination of different insulation materials is used the material with the greater vapour resistance should be located on the warm side.

H.3.2 Internal finishes and ceilings

The internal surface of any roof structure may be left exposed or it may be finished with a surface coating applied direct to the structure, or it may be covered with an internal lining fixed directly to the structure or suspended from it.

At the design stage, it is important to consider how to achieve construction details which will function during the lifetime of the building. High standards of workmanship should be required in the application of ceilings and dry-linings and in the installation of mechanical and electric services.

NOTE 1 Air leakage through gaps in a ceiling or lining allows substantial amounts of heat and moisture to be transferred into the roof by convection. Restricting air leakage by sealing the ceiling or lining using an AVCL or air leakage barrier reduces the transfer of both heat and moisture, improving the energy efficiency of the building and minimizing the risk of interstitial condensation.

Although it is difficult to form a totally airtight ceiling, the transfer of warm moist air may be restricted by providing a ceiling or lining which is continuous, airtight and sealed to all adjacent surfaces. The tops of all cavities in walls and partitions which bypass the ceiling (including those behind plasterboard on dabs or battens) should be sealed to prevent transfer of warm moist air into the roof.

Penetrations of the ceiling plane should be limited, and those which are essential should be fully sealed against air leakage. Loft access hatches and downlighters should not be located in rooms with high rates of moisture generation such as kitchens and bathrooms and should have low air leakage rates. Penetrations for services such as pipework and electrical cables should be sealed, preferably with proprietary collars and gaskets.

The air leakage rate through an access hatch, including its frame, when tested to BS EN 13141-1:2004, 4.3 should be less than 1 m³/h at a pressure difference of 2 Pa. It may be assumed that "push-up" wooden hatch covers in a frame, constructed in-situ, with continuous compressible seals, will meet this criterion provided the weight of the door is at least 5.5 kg. Hatch covers should either be heavy enough to compress a seal or be clamped, with a closed cell compressible seal, or "O-ring" between it and the frame. Drop-down hatch covers are more difficult to seal; it is recommended that proprietary units with a supplied hatch cover in a frame are used. Manufacturers can provide third party evidence that the leakage criterion is met.

Recessed light fittings should either comply with BS EN 60529 and be rated IP60 to IP65 (depending on room use), or incorporate an appropriate sealed hood or box which meets the following test criteria. The total leakage through all downlighters should not exceed $0.06 \text{ m}^3/\text{h}\cdot\text{m}^2$ of ceiling at 2 Pa. The leakage of individual downlighters may be tested using the method specified in BS EN 13141-1:2004, 4.3.

If space permits, a small void may be included between the AVCL and the ceiling lining, which:

- a) provides space to services;
- b) protects the AVCL;
- c) provides extra thermal resistance; and
- d) provides an opportunity to use a reflective AVCL to improve further the thermal performance.

Detailed recommendations on achieving a “well-sealed ceiling” in BS 9250 should be followed.

Designers should take account of the following.

- Suspended ceilings formed with discontinuous units fitted to a suspension system offer only limited resistance to the passage of heat, air and moisture.
- A suspended ceiling which is intended to provide acoustic attenuation incorporates acoustic insulation which also acts as thermal insulation; it offers little or no resistance to the passage of water vapour. As a result, relative humidity of the air in the void between a suspended ceiling and the roof structure is higher than that below the ceiling, increasing the risk of condensation occurring on the underside of the roof structure; designers should carry out a condensation risk assessment.

When an existing building is to be upgraded, refurbished or re-roofed the advantages of improving airtightness of any existing ceiling should be considered.

H.3.3 Air permeability of the external coverings of roofs

COMMENTARY ON H.3.3

The external covering of a roof includes:

- a) any supporting substructure (sheathing or sarking boarding, battens and counter battens);
- b) any underlay (HR or LR);
- c) the external weatherproof layer (tiles, slates, metal, multi- and single-ply).

The likelihood of interstitial condensation occurring within a roof will be affected by the vapour permeability and airtightness of the external roof covering.

The external covering to a flat roof is, of necessity, watertight and therefore impermeable.

The external covering of a pitched roof is impermeable if it incorporates a waterproof finish such as sheet metal or a continuous bitumen or plastics membrane.

The external covering of a pitched roof which incorporates discontinuous units (such as tiles or slates laid on battens) as the external weatherproof layer which is permeable or impermeable depending upon the performance characteristics of tiles, slates, the underlay and the sheathing or sarking.

The designer should take account of the air and vapour resistance offered by the underlay and any supporting material. Thus, an LR underlay, which is fully supported on material which offers a high resistance to the passage of water vapour, such as plywood, oriented strand board (OSB) or chipboard, should be treated for design purposes as an HR underlay. LR underlays laid on open jointed sarking boards, typically 150 mm wide with 2 mm gaps between each board, may be treated, for design purposes, as LR underlays.

NOTE 1 Underlays which can hold or absorb moisture, and re-evaporate it when conditions are more favourable, are beneficial. Underlays with a smooth underside can create problems with condensate run off (see Table A.1).

Ventilation should be provided to any void which occurs beneath any impermeable layer placed on the cold side of any thermal insulation. Ventilation paths should remain unobstructed during the life of the building; particular attention should be paid to ensuring air flow paths are maintained at changes in roof slope, and at details such as penetrations and abutments or fire break walls.

Designers should be aware that an underlay which offers low resistance to the passage of water vapour will tend to lower the risk of condensation in the loft but might increase the risk of condensation in the batten space, leading to decay of the battens unless there is sufficient air movement through the external covering.

The permeability of an external roof covering may be determined by testing as described in BS 5534:2003, Annex L using equipment capable of measuring pressure differences of 2 Pa. The roof covering will allow sufficient air movement if the airflow in m^3/h at a differential of 2 Pa is greater than $7.8A_r$, where A_r is the effective area of the test rig in m^2 . If the airflow is not greater than $7.8A_r$ (in m^3/h), it is necessary to provide either:

- a) 25 mm counterbattens together with ventilation openings to the batten space which are equivalent in area to a continuous slot 25 mm wide in the eaves and 5 mm wide at the ridge; or
- b) ventilation openings to the roof void or air void below the underlay as specified in H.4, H.5 and H.6.

NOTE 2 The permeability of roofing materials such as natural slates, clay and concrete tiles can be expected to exceed $7.8A_r$.

Where the external covering of a roof consists of fully supported sheet metal, there is a risk that interstitial condensation will occur on the underside of the metal, which can lead to corrosion; to reduce that risk, a vapour diffusion layer should be provided immediately beneath the sheet metal.

H.4 Cold pitched roofs

H.4.1 General

Designs should take account of the fact that where the insulation in a pitched roof is placed on the horizontal ceiling [Figure H.1a)] the roof structure and the enclosed attic or loft is colder than the internal occupied spaces.

NOTE 1 There is little risk of surface condensation within the occupied space provided thermal insulation is applied continuously and evenly across the ceiling, with particular attention to achieving continuity of insulation at the wall/roof junction and across the loft access hatch.

NOTE 2 There is a significant risk of interstitial condensation forming on the roof structure and on the underside of the underlay, from where it might run and drip onto the insulation (Table A.1) and some risk of interstitial condensation in the batten space. Persistently high levels of humidity cause hygroscopic materials (such as timber and timber-based products) to absorb sufficient moisture to encourage the growth of moulds and the decay of structural members.

When assessing the risk of interstitial condensation occurring within a cold-pitched roof designers should consider the following inter-related factors:

- a) the internal vapour pressure (which depends upon moisture generation and the degree of ventilation in the occupied spaces);
- b) the rate at which air and water vapour are transferred by air leakage and diffusion from the occupied spaces into the loft (determined by the airtightness and vapour resistance of the ceiling, see **H.3.2**);
- c) the rate at which water vapour:
 - 1) is transported from the loft to outside (determined by the degree of ventilation of the loft); and
 - 2) diffuses through any underlay into the batten space (determined by the vapour resistance and permeability of the underlay);
 - 3) is removed from the batten space (determined by the permeability of the roof covering).

H.4.2 Cold pitched roof with HR underlay

An HR underlay provides high vapour resistance on the cold side of the thermal insulation, preventing the diffusion of water vapour from the loft; it is therefore essential that the loft space be ventilated in accordance with **H.4.4**.

H.4.3 Cold pitched roof with LR underlay

If an LR underlay is used, the designer may provide less ventilation to the loft than is recommended for a roof with an HR underlay (see **H.4.4**).

This code of practice does not consider the situation where it is proposed to provide no ventilation to the roof void, or ventilation more limited than recommended in **H.4.4**.

The loft should be ventilated in accordance with **H.4.4**, except in cases where limited or no ventilation to the loft space is proposed, in which case it is recommended that reference be made to the conditions attached to Technical Approvals given by UKAS (or European equivalent) accredited technical approval bodies.

In roofs with an LR underlay (Figure H.2 and Figure H.3) moisture can move by both diffusion and convection from the loft into the batten space; to avoid the risk of damaging interstitial condensation in the batten space, the following recommendations should be followed:

- a) If the external roof covering is sufficiently air permeable to allow vapour to disperse safely to atmosphere (see **H.3.3**) there is no need to provide ventilation of the batten space.
- b) If the external roof covering is not sufficiently air permeable (see **H.3.3**) the batten space should be ventilated; this may be done by means of counterbattens and vents at both low and high level. Low level vents should be equivalent in free area to a slot 25 mm deep running the whole length of the eaves. High level vents should be equivalent in area to a slot 5 mm deep running the whole length of the ridge. Alternative means of ventilation should provide an equivalent level of ventilation.

- c) If the external roof covering is not sufficiently air permeable (see H.3.3) and the batten space is not ventilated, then the design should revert to that described in H.4.4.

Most LR underlays are airtight, however some are air permeable to a degree; this can allow air movement from the loft space through the underlay into the batten space thereby reducing the risk of condensation on the underlay and cold structure.

Where an LR underlay is installed on continuous sheathing or continuous sarking, the roof should be treated, for design purposes, as having an HR underlay, and ventilated voids should be provided as described in H.4.4.

Figure H.2 Cold pitched roof – LR underlay – Permeable external covering

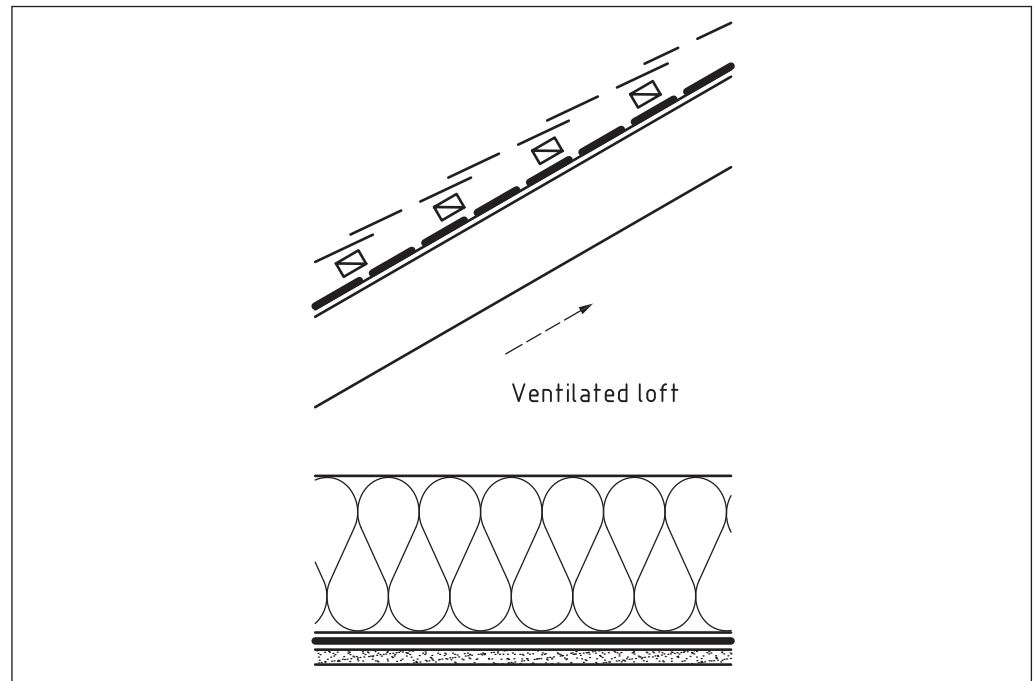
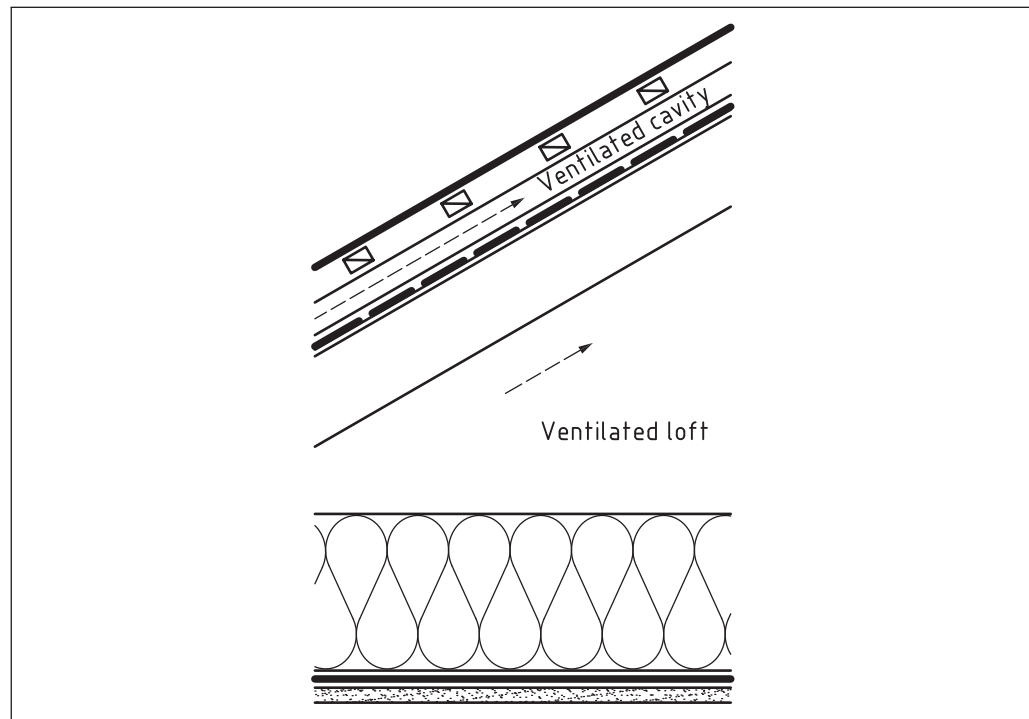

Figure H.3 Cold pitched roof – LR underlay – Impermeable external covering



H.4.4 Ventilation of lofts

NOTE 1 This standard assumes that ventilation of a loft will be provided by natural means (passive ventilation), reliant upon variable wind speed and direction, and differential air temperatures.

It is important to allow continuous air movement to draw air from the loft and allow it to be replaced with an equal quantity of external air. Vents should be designed to prevent the entry of birds, bats and large insects (a 4 mm mesh or grill will achieve that without excessive resistance to airflow), and should remain unobstructed during the life of the roof. In order to overcome surface resistance to air flow, airways should be at least 25 mm deep. Ventilation should be designed to avoid creating pockets of stagnant air.

The optimum size and disposition of vents should be determined by the size and shape of the loft; large and/or complex roofs may require vents at both high and low level. For simple domestic roofs up to 35° of pitch, vents on opposite sides of the roof, either in gables or at eaves, are recommended as they are likely to provide adequate ventilation. For recommended vent areas to such roofs see Table H.1. In larger or more complex roofs it might be necessary to provide additional vents at high level.

There is an increased risk of condensation during any drying out period and the need for additional measures to remove excess moisture incorporated during construction should be assessed (see 4.3.3).

NOTE 2 In hipped or pyramidal roofs where the length of the ridge is less than that of the eaves, the provision for high level ventilation can be reduced using:

$$A_{\text{req}} = \frac{A_{\text{gable}} V_{\text{actual}}}{V_{\text{gable}}}$$

where

A_{req} is the required high level vent area

A_{gable} is the area calculated from the longest horizontal dimension (i.e. as if the roof had gable ends)

V_{actual} is the volume of the actual hipped or pyramidal roof

V_{gable} is the volume that the roof would have had if it had gable ends.

Table H.1 Minimum low level loft space ventilation openings

Pitch	Underlay	Ceilings	Vents with area equivalent to (mm)
10° to 15°	HR ^{A)}	Any	25 × longest horizontal dimension of roof
>15° and <75°	HR ^{A)}	Any	10 × longest horizontal dimension of roof
10° to <75°	LR	Normal	7 × longest horizontal dimension of roof
		Well-sealed	3 × longest horizontal dimension of roof ^{B)}

^{A)} An additional high level vent 5 mm × longest horizontal dimension of roof should be provided where:

- the pitch exceeds 35°; or
- the span exceeds 10 m; or
- the roof is a lean-to or monopitch.

^{B)} Alternatively, high level vent 5 mm vent × longest horizontal dimension of roof should be provided.

H.5 Warm pitched roofs

H.5.1 General

The condensation risks associated with a large unheated void in a pitched roof can be avoided if the thermal insulation follows the line of the roof pitch [Figure H.1b)]; however, designers should be aware that there might still be a risk of interstitial condensation within the roof structure.

When assessing the risk of interstitial condensation within a warm pitched roof, designers should take the following inter-related factors into account:

- the airtightness of the ceiling, which determines how much heat, air and water vapour are transferred by convection;
- the vapour resistance of the ceiling, which determines how much water vapour will be transferred across the ceiling;
- the vapour resistance (LR or HR) of any underlay;
- the air permeability of the external covering of the roof, which determines the rate at which water vapour can disperse by diffusion and convection;
- use of an AVCL which will determine how much water vapour will be transferred to the roof both by diffusion; and convection;
- the degree and location of the thermal insulation within the structure.

NOTE There is little risk of internal surface condensation provided thermal insulation is applied continuously and evenly, with particular attention to achieving continuity at the wall/roof junction.

Ceilings should be formed in accordance with the recommendations in H.3.2 to minimize the transfer of water vapour by air movement and to resist transfer by diffusion and convection.

H.5.2 Warm pitched roof with HR underlay

In roofs with an HR underlay (Figure H.4), whatever form of external covering or ceiling is provided, there is a risk of interstitial condensation forming on the underside of the HR underlay; to avoid that risk, an AVCL should be provided on the warm side of the insulation, and ventilated voids should be formed between the underside of the underlay and the insulation. Each void should be at least 25 mm deep and be vented at both high and low level.

NOTE A nominal 50 mm gap is likely to be reduced to 25 mm under the drape.

Openings at low level should have free area equivalent to 25 mm × the width of the void and those at high level 5 mm × the width of the void.

Vents should be provided on both sides of any obstruction, e.g. a horizontal ridge, fire break wall, roof window or dormers.

Figure H.4 Warm pitched roof with HR underlay – Any roof covering

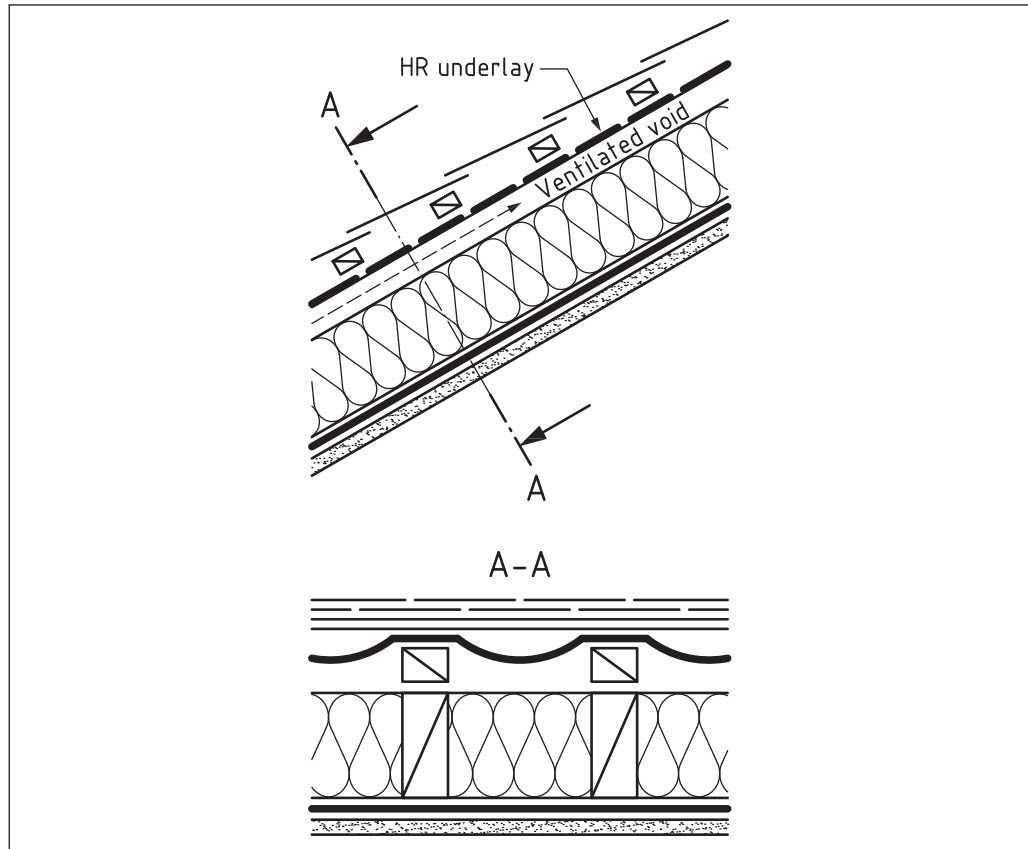

H.5.3 Warm pitched roof with LR underlay

In warm pitched roofs with LR underlay (Figure H.5), an AVCL should be provided at ceiling line. If the external covering is sufficiently permeable (see H.3.3) it will allow vapour to be released to atmosphere and no ventilation of the batten space is recommended.

If it is not practicable to provide an AVCL there might be some risk of interstitial condensation forming on the underside of the underlay; to avoid that risk ventilated voids should be provided as in H.5.2.

Where an external covering (such as fibre cement slates) is relatively airtight (see H.3.3) there is a risk of interstitial condensation forming on the underside of the underlay and the external covering; to avoid that risk the batten space should be vented as H.3.3 (Figure H.6).

Figure H.5 Warm pitched roof with LR underlay and permeable roof covering

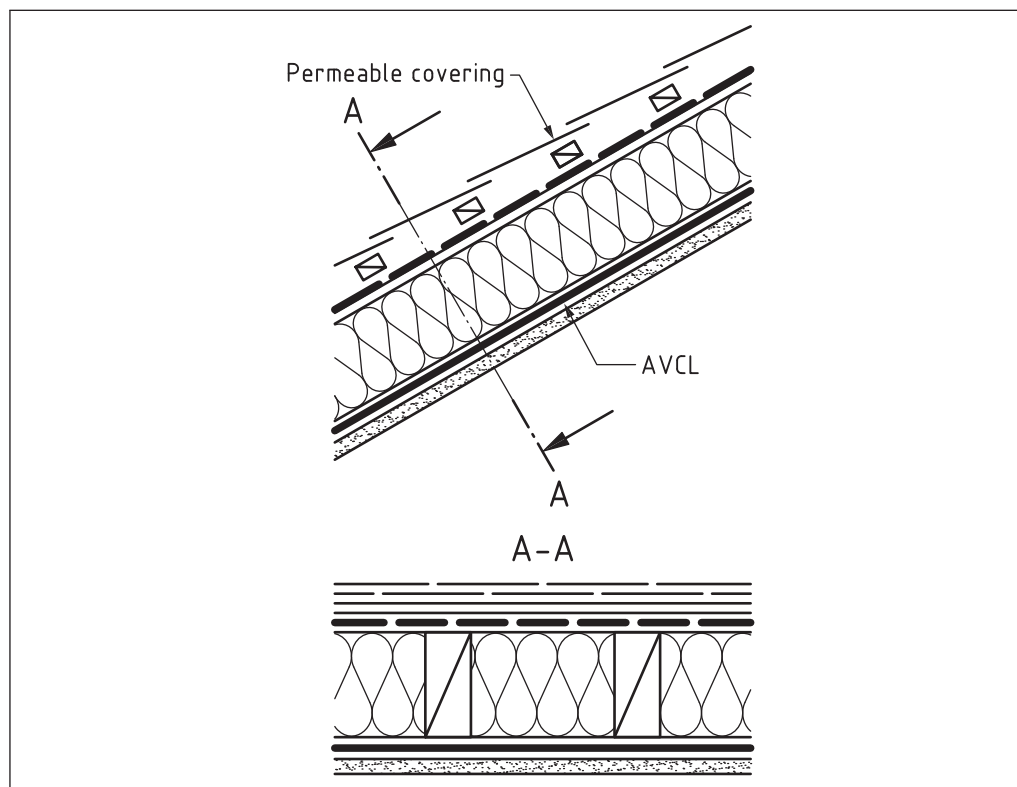
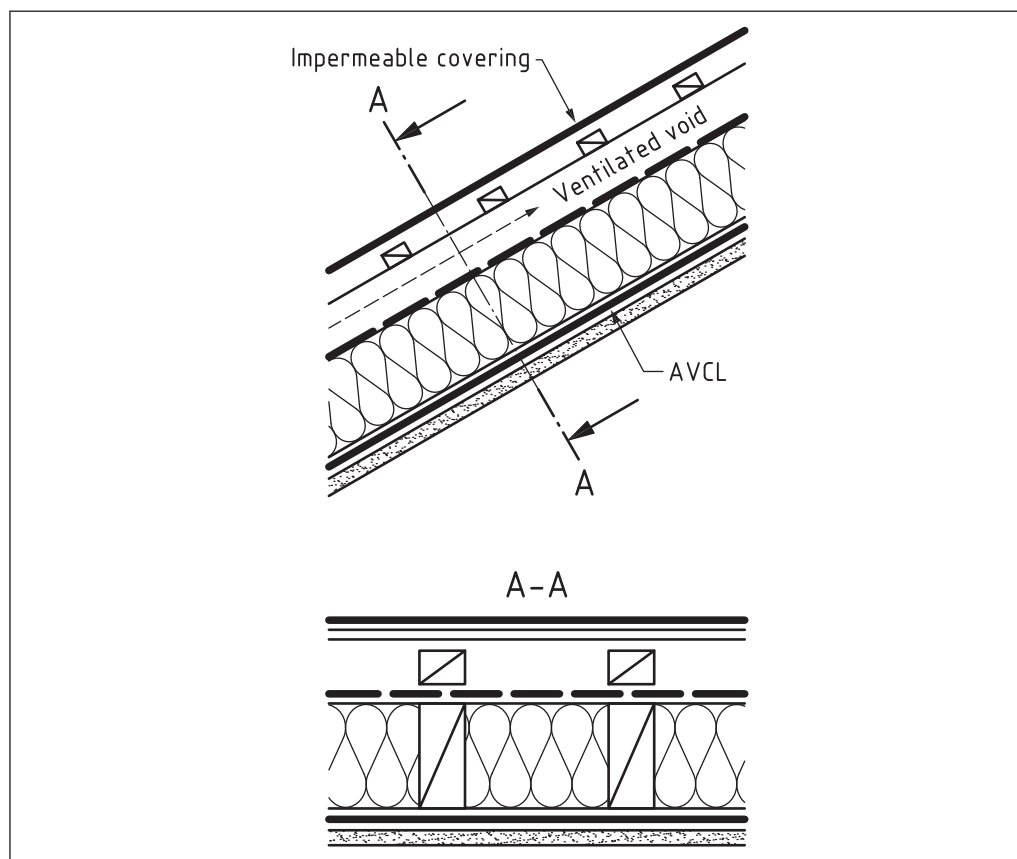

Figure H.6 Warm pitched roof with LR underlay and impermeable roof covering



H.6 Hybrid pitched roofs

NOTE In this standard the term 'hybrid pitched roof' is used to describe roofs which contain both conditioned and unconditioned spaces [Figure H.1c)].

Designers should be aware that this form of construction is less efficient and more difficult to form than warm pitched construction [Figure H.1b) and Figure H.1d)], however it is frequently adopted in the adaptation of existing buildings. Great care and attention to detail is recommended in to achieving continuity of the insulation and the AVCL in a hybrid pitched roof (see Figure H.7), and it might not be possible to achieve an airtight ceiling.

To avoid the risk of interstitial condensation, ventilation should be provided to each sector of the roof in accordance with the relevant recommendations of H.4 or H.5.

Figure H.7 Routing insulation and AVCL in a hybrid pitched roof to achieve continuity

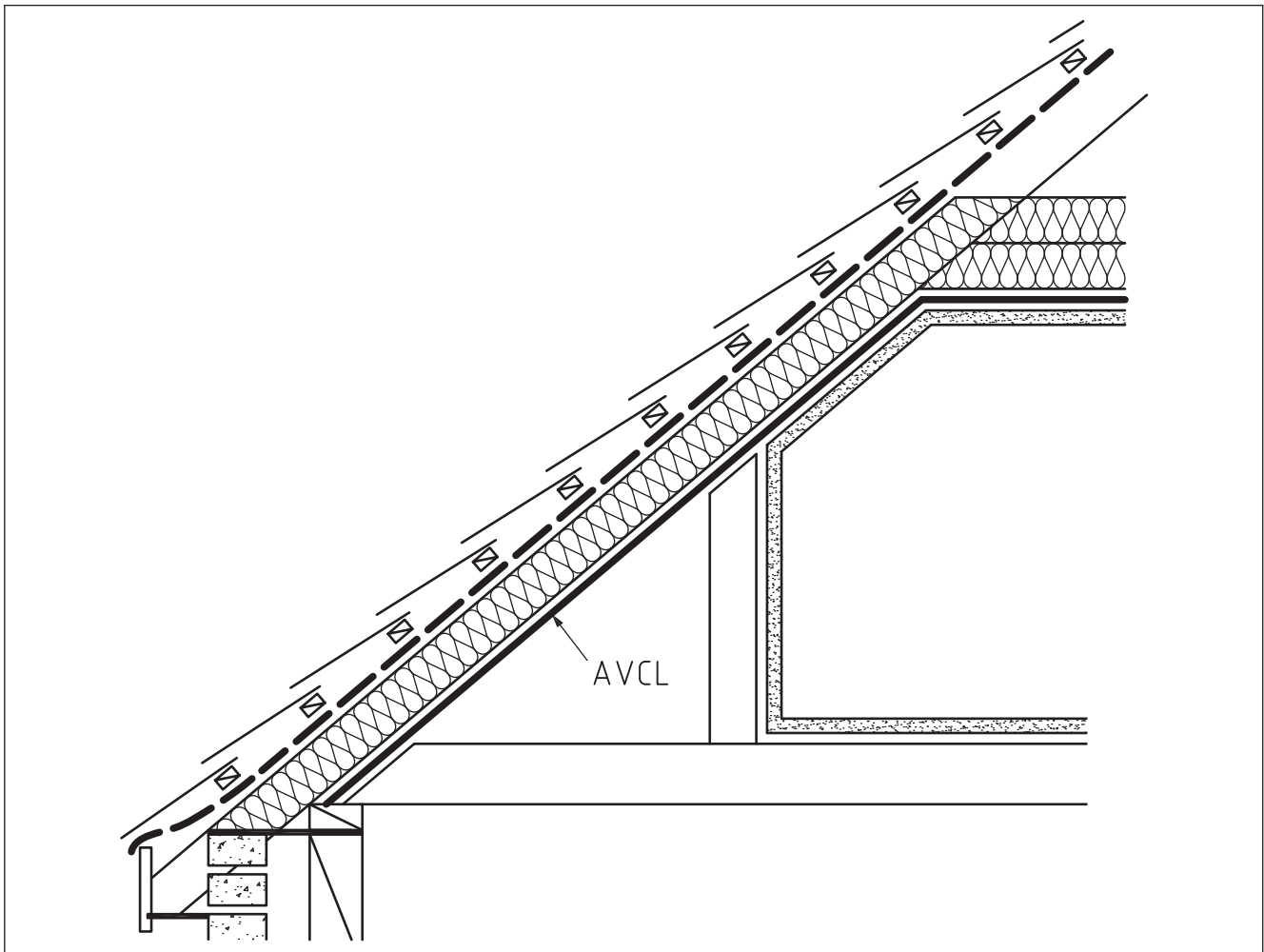

H.7 Cold flat roofs

H.7.1 General

NOTE 1 Surface condensation is unlikely to occur in flat cold roofs because the thermal insulation maintains the internal finish at room temperature.

Designers should be aware that it is difficult to avoid interstitial condensation in cold flat roofs. To avoid the risk of interstitial condensation, an AVCL should be provided on the warm side of the insulation and there should be a cross-ventilated void, not less than 50 mm deep, between the slab or deck and the insulation (Figure H.8 and Figure H.9).

Ventilation openings should be provided to every roof void along two opposite sides of the roof and should be equivalent in area to a continuous opening of not less than 25 mm at each side.

NOTE 2 For large roofs, the dimensions of the cross-ventilated void and the ventilation might have to be increased.

Figure H.8 Cold flat roof – Framed structure

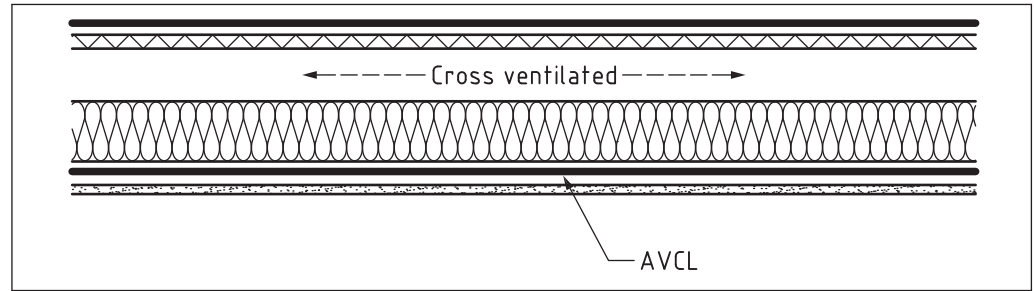
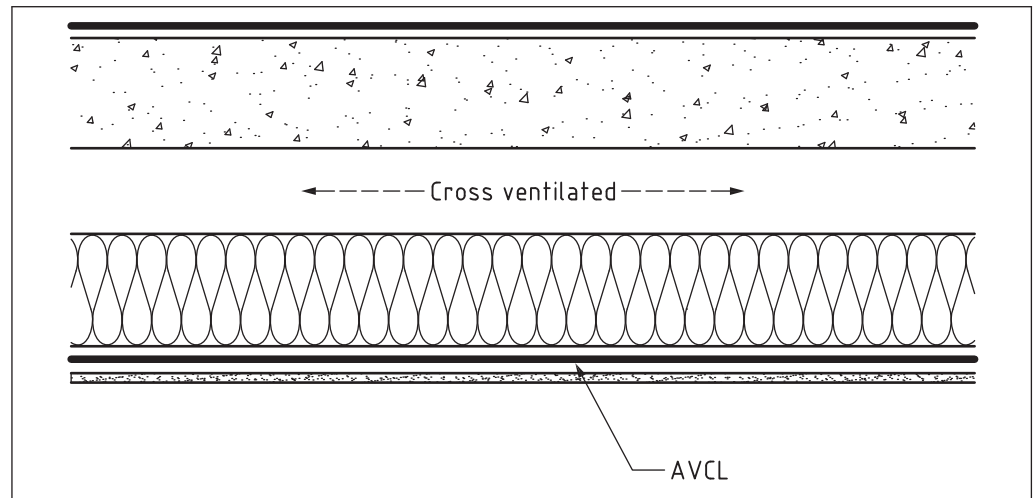

Figure H.9 Cold flat roof – Dense structure



H.7.2 Metal deck

Designers should be aware that the risk of surface condensation on the underside of fully supported metal depends on the performance of the AVCL below the insulation and the risk of moisture vapour ingress through unsealed joints in the roof covering.

Fully supported metal roofs should include a separating layer between the metal and structural support (e.g. plywood), this separating layer should provide for moisture diffusion into the cross ventilated space and air circulation.

H.8 Warm flat roofs

Designers should be aware that the risk of surface condensation in a warm flat roof depends upon the nature of the supporting structure: there is no risk of surface condensation on warm flat roofs with framed structure (Figure H.9), however there is a risk of surface condensation if the supporting structure consists of a concrete slab and the building is heated only intermittently (Figure H.10)

With all warm flat roofs there is a risk of interstitial condensation forming between the thermal insulation and the waterproof covering; to avoid that risk, an AVCL with vapour resistance at least equal to that of the waterproof covering, should be provided immediately above the supporting structure. The AVCL should be wrapped around the edges of the insulation and sealed to the waterproof finish at the perimeter and all penetrations.

Figure H.10 Warm flat roof – Framed structure

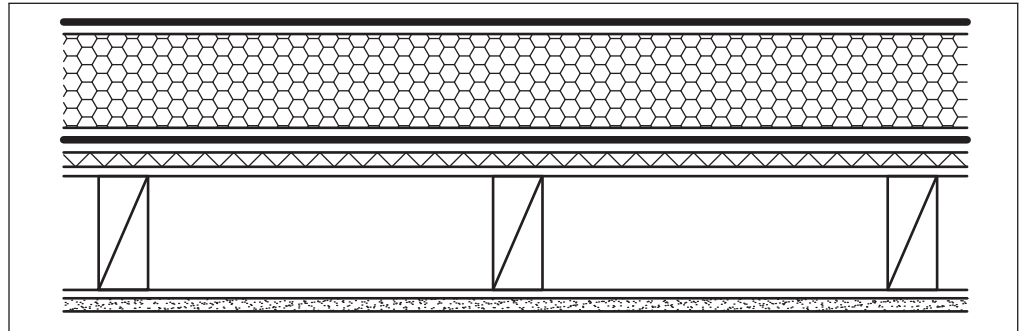
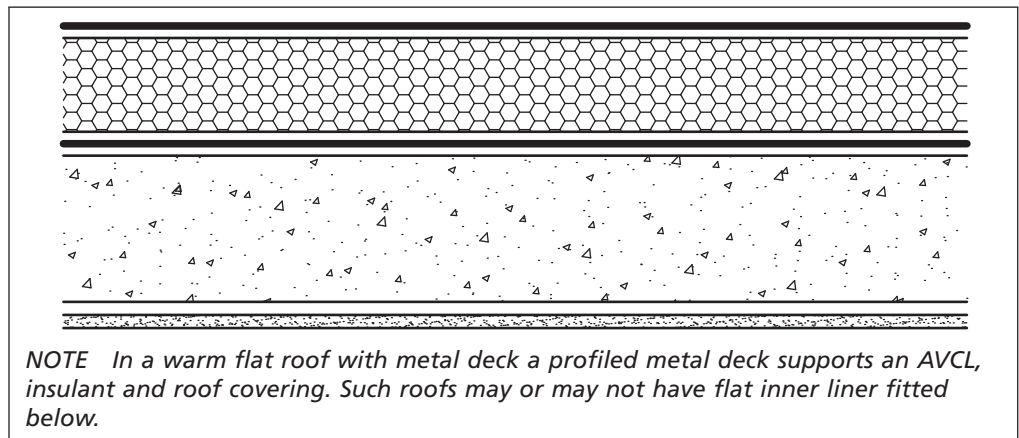

Figure H.11 Warm flat roof – Dense structure



H.9 Inverted flat roofs

It is essential that the thermal insulation used in an inverted flat roof resists water absorption and is sufficiently loadbearing to support the protective finish of ballast, paving or soil.

NOTE 1 There is no risk of surface condensation on inverted flat roofs with a framed structure (Figure H.11), however, there is a risk of surface condensation if the supporting structure consists of a concrete slab and the building is heated only intermittently (Figure H.12).

NOTE 2 There is no risk of interstitial condensation in inverted flat roofs, irrespective of the form of the supporting structure, as the insulation maintains the impermeable waterproof covering above dewpoint.

NOTE 3 Rainwater movement into and under the insulation will have a significant detrimental effect on the thermal performance.

Figure H.12 Inverted flat roof – Framed structure

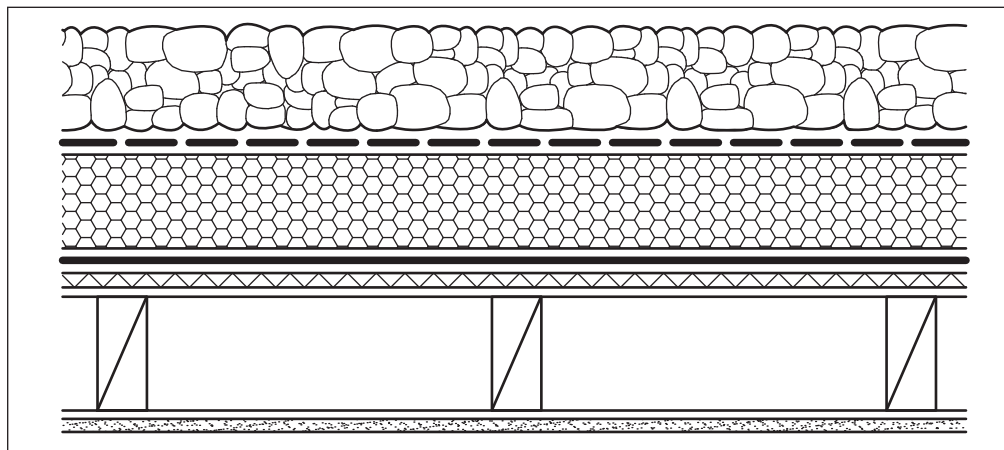
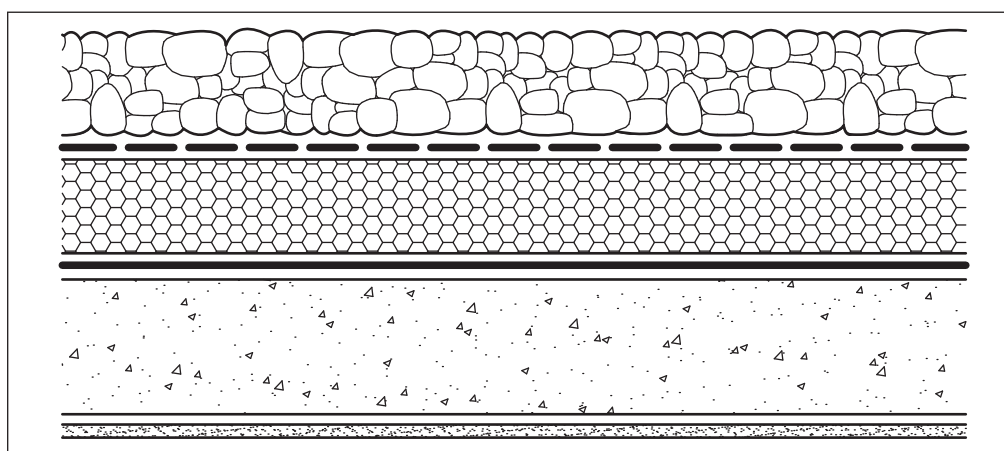

Figure H.13 Inverted flat roof – Dense construction



H.10 Self-supporting sheeted metal

H.10.1 General

Profiled metal sheets, self-supporting across structural framing, are commonly used at low pitch to roof both un-heated and heated buildings. If used as an un-insulated roof covering to unheated buildings, such as garages, storage facilities and animal sheds there is a risk condensation might form on the underside of the metal sheets. Condensate can then drip and cause damage to the building fabric and/or harm to the building contents/occupants. Consideration should therefore be given to measures to remove that condensate before it can cause damage.

Self-supporting profiled metal sheets may be used in combination with thermal insulation to form the roof of a heated building. Such a roof may be constructed by assembling components on site or by the use of pre-fabricated roof panels.

H.10.2 Site-assembled sheet metal roofs

Site-assembled sheet metal roofs comprise an inner lining of pre-formed metal trays laid across purlins, fibrous thermal insulation to fill the trays and an external roof covering of profiled sheet metal.

The performance in use of such roofs is strongly influenced by the degree of weather protection provided during their assembly and by the quality of workmanship – particularly in ensuring continuity of insulation.

There is a risk of condensation occurring on the underside of the external sheet and dripping into the thermal insulation thereby reducing overall thermal performance. To avoid that, all site-assembled sheet metal roofs should incorporate an AVCL on the warm side of the thermal insulation; a breather membrane may be required immediately beneath the outer sheet. The internal metal liner tray may constitute an AVCL provided all joints between trays and all penetrations are fully sealed.

All voids formed by the profile of the outer sheet metal roof covering should be ventilated. Ventilation can be achieved by leaving open the profile and both ends of the sheeting: if profile fillers are fitted they should leave a free area of not less than 5% of the cross sectional area of the void.

Figure H.14 Site assembled metal roof

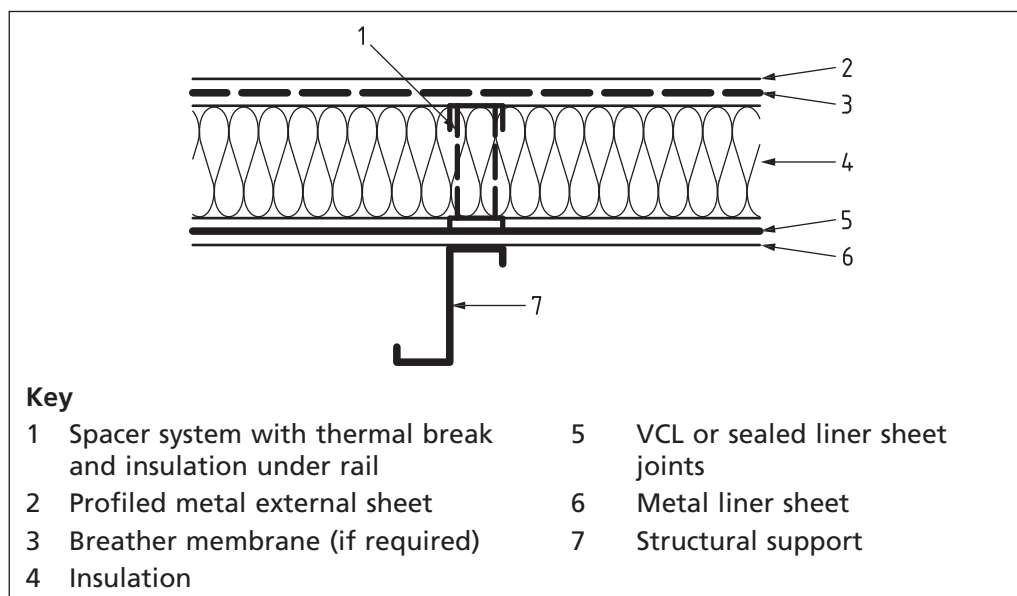

H.10.3 Pre-formed (composite) insulated roof panels

Roofs may be formed with factory-formed panels consisting of inner and outer sheet metal coverings bonded to a thermal insulant. The insulant may be auto-bonded to the metal facings or pre-formed and bonded with adhesive to the facings.

Provided the insulant fully fills the space between the metal facings, the impermeable metal internal lining prevents water vapour diffusing into the interior of the panel, eliminating any risk of interstitial condensation. However, water vapour diffusion is still possible at panel edges. Condensation can form in any spaces near the cold facing.

Figure H.15 Composite panel roof

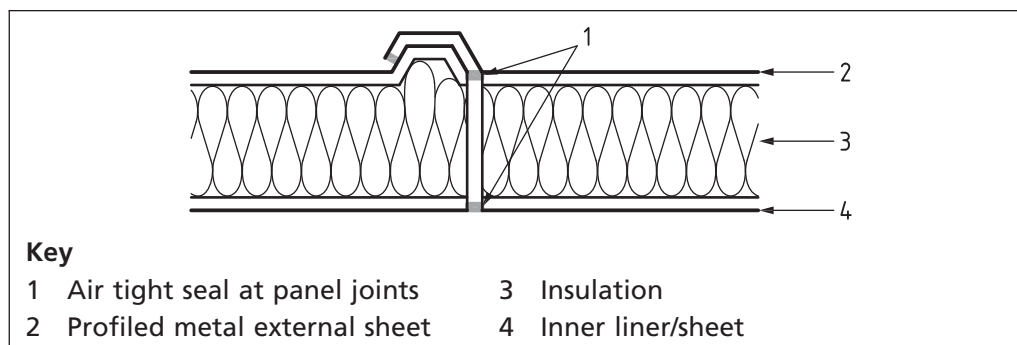

H.11 Structural insulated panels (SIPS)

SIPS consist of inner and outer surface layers bonded to a thermal insulant. The insulant may be auto-bonded to the surface layers or pre-formed and bonded with adhesive to the surface layers.

There is no risk of surface condensation with such panels, nor will interstitial condensation occur provided the vapour resistance of the inner surface layer is equal to or greater than that of the outer layer and all joints between the panels are sealed.

H.12 Openings in roofs

Roofs can incorporate openings to accommodate components such as rooflights and they can be penetrated by pipes and services such as extract fans; at the perimeter of such openings there is a risk of interstitial condensation occurring on the internal surfaces as a result of thermal bridging (see Annex J); to avoid that risk, all such penetrations should be carefully sealed to the vapour control plane.

Where rooflights used in conjunction with site-formed, twin-skin metal roofing are formed on site, the inner sheet should be sealed to the AVCL to minimize the risk of condensation.

Pre-formed, sealed rooflights present little risk of condensation; when used in conjunction with composite metal panels the inner skin of the rooflight should be sealed to the internal lining of the panel to form a continuous AVCL. Where pre-formed sealed rooflights are used with site-formed, twin-skin metal roofing, the junction between the rooflight and metal liner should be fully sealed to prevent air leakage into the roof.

Rooflights which project through the roof should be fitted to insulated upstands to reduce surface condensation, and the VCL should be sealed to the upstand.

H.13 Refurbishment

The characteristics of an existing roof may be modified by refurbishment or renovation of an existing building, or the "fit out" of a new building shell. The risk of condensation occurring within the roof should be carefully evaluated taking account of both changes of use of the building and changes to the structure of the building.

NOTE Examples of work likely to introduce or increase the risk of localized condensation include:

- a) *the addition of insulation to improve the thermal performance;*
- b) *the installation of acoustic insulation above a ceiling which will reduce the temperature of the void above the ceiling;*
- c) *compromising the airtightness of a ceiling, for example by introducing recessed light fittings;*
- d) *changing the roof covering; for example, replacing natural slates (which form an air permeable covering) with fibre-cement slates which form a less air permeable covering;*
- e) *installing a new roof covering which incorporates an underlay where none was previously provided;*
- f) *converting an uninsulated attic into a habitable space, which both increases the rate of moisture generation within the attic and introduces new insulation and ceiling lining.*

Annex J
(informative)
J.1

Application of design principles at junctions

Heat loss and surface temperatures

From the point of view of energy and moisture performance the fabric of a building consists of a series of planes and the junctions between them:

The junctions contain a number of features that make their heat, air and moisture performance significantly different from the plane areas:

- the geometry is complex so that heat and moisture flow will be two or three dimensional and not a simple path from inside to out; and
- at junctions like corners, where two external walls meet or the eaves of a roof, the area of the external surface is greater than the internal surface, giving greater potential for heat loss (Figure J.1); and
- some junctions (e.g. window or door lintels) can contain structural elements like steel or concrete, which have higher thermal conductivity than surrounding materials (Figure J.2).

If the heat flow through a junction is higher than the surrounding areas, the internal surface temperature will be lower, leading to an increased risk of localized surface condensation and mould growth.

Because of the increased heat flows, these junctions have been commonly called "thermal bridges" or even "cold bridges". Besides these junctions, many fabric elements contain features such as timber joists, mortar joints, or mullions in curtain walling. These are known as "repeating thermal bridges" and have a significant effect on heat loss. They are, however, rarely severe enough to cause surface temperatures to fall low enough to cause surface condensation or mould growth.

Figure J.1 Temperature contours and heat flow lines at a corner on a masonry wall with insulated cavity

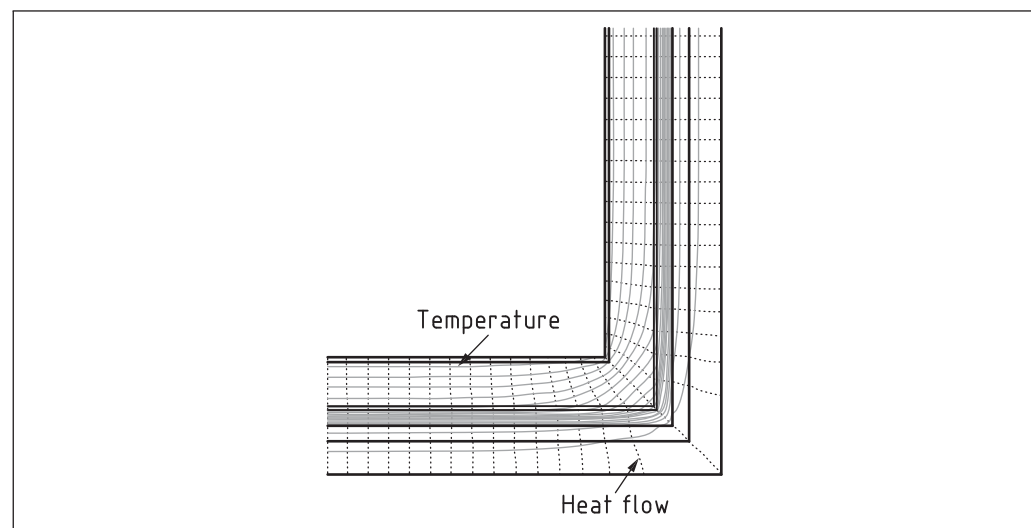
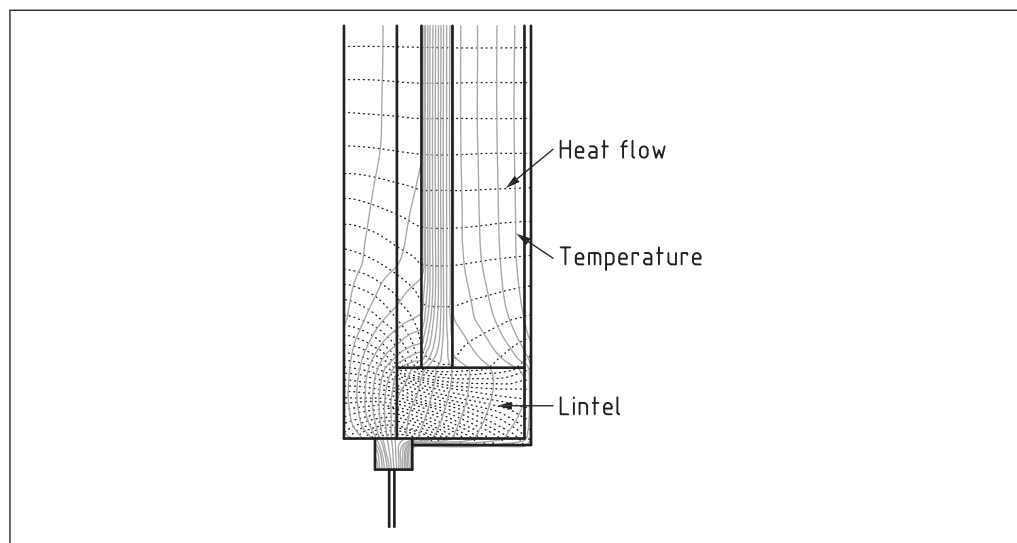

Figure J.2 Temperature contours and heat flow lines through a concrete lintel in a masonry wall with insulated cavity



J.2 Classification of thermal bridges

The severity of a thermal bridge, in terms of its effect on internal surface temperatures may be expressed by the surface temperature factor f defined under steady state conditions by:

$$f = \frac{T_{si} - T_o}{T_i - T_o}$$

where:

T_{si} is the internal surface temperature

T_i is the internal air temperature

T_o is the external air temperature.

NOTE This will be close to 1.0 for a well insulated structure, but will fall towards 0.5 or below at severe thermal bridges.

As it depends on the properties of the construction detail alone and is independent of the environmental conditions, once the temperature factor has been found for a thermal bridge, it may be used to calculate the internal surface temperature from any set of temperatures:

$$T_{si} = T_o + f(T_i - T_o)$$

This may then be used to calculate the internal surface relative humidity and risk of mould growth, if the internal humidity is known.

A surface temperature factor of not less than 0.75 is considered to be sufficient to avoid mould growth, given the range of conditions in UK buildings and the UK climate. This is discussed further in BS EN ISO 13788 and BRE Information Paper IP 1/06 [9].

The surface temperature factor of a thermal bridge may be found from thermal bridge catalogues or by calculation. A wide range of software packages are also available, which may be used to carry out the appropriate calculations with two or three dimension thermal model. This software should conform to BS EN ISO 10211. However, thermal bridge calculation software is complex and is currently used only by specialist consultants. Guidance for calculation is given in BRE Report BR 497 [10].

Thermal bridge catalogues have been produced that contain a representative sample of building details, identify possible problems and give recommended solutions. These catalogues have the advantage of simplicity and ease of use and cover most common constructions. The most comprehensive examples in the UK are the Energy Efficiency Office Good Practice Guides 174 and 183 [11,12], which cover new and existing housing respectively, and the DEFRA/DETR Report on thermal bridging [13] published in association with the Building Regulations.

Sets of Accredited Construction Details, which are designed to minimize problems of heat loss, condensation risk and air infiltration are available for England and Scotland [14, 15]. A list of enhanced details for low-thermal-bridge parameters are given in the Energy Saving Trust *Enhanced Construction Details* [16]. Specific guidance for sheeted metal constructions is given in MCRMA Technical Paper 18 [17].

Annex K
(informative)

Application of design principles – Occupied space ventilation

K.1 General

COMMENTARY ON K.1

GPG 268 [18] provides an overview of the issues relating to domestic ventilation.

Older properties might only have openable windows as a ventilation provision but might be able to adopt one of the following systems (see the Building Regulation guidance on ventilation [19,20,21]).

New buildings are progressively being constructed in a tighter form (reduced air permeability). This will therefore require more consideration to be given to the ventilation system(s) to be installed to ensure that any build up of condensation is reduced to a minimum.

As fabric energy efficiency standards progressively improve, limiting heat loss through ventilation (either intended or unintended) becomes increasingly important. Clearly there is a balance to be struck between restricting unnecessary ventilation and the subsequent heat loss and the control of condensation.

Correct system design and installation is a vital part of an efficient system. Adequate, efficient ventilation will contribute greatly to the health not only of the occupant but also of the building.

Increased use of ventilation controls can minimize energy consumption, either:

- *controlled ventilation – providing some form of regulation to the system, normally by user intervention; or*
- *demand controlled ventilation – providing regulation to the system dependant upon the local environmental conditions, without user intervention.*

Examples of types of control are:

- *humidity controlled fan (stand alone controller or integral with fan);*
- *humidity controlled trickle ventilator;*
- *timer;*
- *PIR (presence sensor);*
- *air quality sensor (i.e. CO₂).*

This list is not exhaustive.

Continuous mechanical ventilation systems operate at low levels but have the facility to boost to reduce the threat of condensation.

Background ventilation will differ depending on construction details and the Building Regulation guidance on ventilation [19,20,21].

Forced ventilation is more reliable than natural ventilation because air change rates and flow directions can be better controlled. Natural or passive ventilation methodologies have the advantage of not needing an energy using fan. Forced ventilation may also be used for short periods to assist natural ventilation.

The whole life cost of ventilation systems should be considered. This should include attention to the specific fan power (SFP).

Many fans used within the ventilation industry now use high efficiency motors and will therefore consume less electrical energy than previously; care should however be exercised when choosing a fan to ensure that it will meet required air flow rates when installed. Manufacturer's data should be checked. Standards that should be referenced are given within the following subclauses.

Performance standards for products that may be included in more than one system include:

- *BS EN 13141-1, Externally and internally mounted air transfer devices*
- *BS EN 13141-2, Exhaust and supply air terminal devices*
- *BS EN 13141-9, Externally mounted humidity controlled air transfer device*
- *BS EN 13141-10, Humidity controlled extract air terminal device*

K.2 Background ventilators and intermittent extract fans

Intermittent fans may be provided in rooms/areas where moisture or other pollutants to the air are generated.

NOTE 1 Replacement air has to be provided through appropriately sized air supply devices as defined in the Building Regulation guidance on ventilation [19,20,21], CIBSE Guide B [22] and their equivalents.

As a general rule, background ventilators should be located in all rooms with an outside wall, including kitchens, bathrooms, sanitary and utility rooms (wet rooms). Extract fans should be located in kitchens and wet rooms. Background ventilators should not be located within 500 mm of an extract fan to avoid short circuiting of the extracted air.

NOTE 2 BS EN 13141-4, gives requirements for the performance of fans.

K.3 Cooker hood (range hood)

Cooker hoods should be installed directly above a cooking area; they are generally regarded as intermittent extract fans.

COMMENTARY ON K.3

Some cooker hood performance requirements are specified by regulations. These products will capture the moisture generated by the cooking process and will exhaust it directly to the outside.

Recirculating cooker hoods do not meet any ventilation requirement and do not remove moisture from the room.

BS EN 13141-3 gives requirements for the performance of cooker hoods.

K.4 Passive stack ventilation

NOTE 1 Passive stack ventilation (PSV) is a ventilation system using ducts from the ceiling or walls of a room to terminals on the roof which operate by a combination of the natural stack effect, i.e. the movement of air due to the difference in temperature between inside and outside and the effect of wind passing over the roof of the building.

In order to maximize the stack effect, ducts should be mounted as near vertical as possible, and should never be at an angle of more than 45° to the vertical. Ducts should be insulated, to prevent any condensation within the duct, where they pass through unheated spaces such as lofts.

NOTE 2 The free space within the duct will determine the air flow and is specified in building regulation guidance. Humidity sensitive grilles are available that provide reduced air flows and heat loss when water vapour is not being generated.

Background ventilators (trickle ventilators) should be provided in the rooms where moisture is not produced (dry rooms) so that air is drawn through these dry rooms to exit via the moisture producing areas (wet rooms) through the stack effect.

NOTE 3 Humidity sensitive grilles are available that provide reduced air flows when water vapour is not being generated. Further information on these systems is defined in the Building Regulation guidance on ventilation [19,20,21], CIBSE Guide B [22], BRE IP13/94 [23] and their equivalents.

K.5 Natural ventilation

NOTE 1 In many existing buildings, the only control that the occupier has of the ventilation is openable windows. In winter, the method is unlikely to be used unless the window incorporates provision for controllable background ventilation.

Where trickle ventilation is not provided, controllable slot ventilators should be installed in the windows or walls. Ideally, these ventilators should be installed in the top section of the window, typically 1 700 mm above floor level, as this will minimize the possibility of draughts.

These background ventilation openings should be installed in all occupied rooms.

NOTE 2 The required size for these openings varies depending on the region and building use. Further information on these systems is defined in the Building Regulation guidance on ventilation [19,20,21], CIBSE B [22].

While such small ventilation openings will normally provide adequate background ventilation, they are unlikely to be able to cope with high amounts of water vapour production; natural ventilation may therefore be supplemented by mechanical extract systems or PSV in the moisture producing areas to remove the water vapour to the outside of the building.

Ideally, when using natural ventilation, outside air should be drawn in through the dry rooms, located on the windward side of the building, to exit via the wet rooms which should be on the leeward side of the building.

K.6 Continuous mechanical ventilation

K.6.1 Mechanical extract ventilation systems.

NOTE 1 Mechanical extract ventilation systems (MEVs) consist of a continuously running fan, usually mounted in a central location to extract air from the wet rooms.

MEVs should be capable of extracting air at a slow continuous rate, and of increasing the flow rate as required. Background ventilators (trickle ventilators) should be provided in all dry rooms to provide make up air.

Single room MEVs that run continuously may also be used.

NOTE 2 Further information and performance requirements for these systems is defined in the Building Regulation guidance on ventilation [19,20,21], CIBSE B [22].

NOTE 3 BS EN 13141-6 gives requirements for the performance of MEVs.

K.6.2 Mechanical supply ventilation systems

COMMENTARY ON K.6.2

Supply ventilation systems (sometimes referred to as positive input ventilation – PIV) are fans that are often mounted in the roof space, which supply air continuously to the centre of the house, usually through the ceiling of the landing. Besides providing a continuous supply of outside air, these systems can benefit from some degree of solar gain in the roof, supplying air that is warmer than outside.

These systems can drive moist air through gaps and holes into cold parts of the structure where interstitial condensation may occur. This condensation can be damaging in some wall constructions e.g. timber frame and SIPs.

Systems that draw air from the roof are not suitable for unventilated roof spaces.

Care should be taken to ensure that PIV fans are as quiet as possible and are not mounted in a way that might cause resonance. The inlet air supply terminal should be installed so that the effect of cold draughts is minimized. Background ventilators (trickle ventilators) should be provided in all rooms to allow for air to disperse to the outside.

Although there is currently no specific standard for this type of fan, it might be possible to use BS EN 13141-4, which gives requirements for the performance of fans.

K.6.3 Continuous mechanical supply and extract with heat recovery

All ducts within the unheated space (loft) should be insulated to minimize condensation on or within the ducts. There might also be a need to provide for the removal of any condensate that might accumulate within the unit; instructions should be given by the manufacture of the MVHR unit. Care should be taken to ensure that the fans are as quiet as possible and are not mounted in a way that could cause resonance.

Background ventilators (trickle ventilators) should *not* be provided as these units provide balanced ventilation; indeed MVHR requires that fabric air permeability is reduced to a minimum for it to operate near its ideal efficiency.

COMMENTARY ON K.6.3

Whole house, mechanical ventilation with heat recovery (MVHR) is a balanced ventilation system that combines supply and extract ventilation in one system. Whole dwelling units comprising of two fans and a heat exchanger may be installed as loft mounted, wall mounted or floor standing. The supply fan continuously provides outdoor air to all habitable rooms (dry rooms) using a system of ductwork. The extract fan removes the moist air from kitchens, bathrooms and utility rooms (wet rooms) via a system of ductwork and passes it across the heat exchanger before it is passed to the outside. The recovered heat preheats the incoming outdoor air.

Individual room heat recovery ventilators are also available. These are mounted in the external wall and consist of two fan impellers with one or two motors and a heat exchanger. They are generally un-ducted units. Warm air is extracted from the room and is passed across a heat exchanger. The recovered heat is transferred to the incoming outdoor air.

All units normally have multiple speed settings permitting continuous background ventilation with a provision to increase the flow rate.

Further information and performance requirements on these systems is given in the Building Regulation guidance on ventilation [19,20,21], CIBSE B [22].

BS EN 13141-7 gives requirements for the performance of whole house heat recovery ventilators.

BS EN 13141-8 gives requirements for the performance of single room heat recovery ventilators.

K.6.4 Exhaust air heat pump (combined unit)

A typical exhaust air heat pump should have a required minimum airflow of not less than 110m³/h (31 L/s). The area in which the unit is installed should also be ventilated; typically this would be 36m³/h (10 L/s).

COMMENTARY ON K.6.4

Exhaust air heat pumps require a minimum air flow to operate satisfactorily and this can have limitations for smaller properties where the required minimum airflow could provide too much ventilation for the floor area of the dwelling

These units have an airflow adjustment to increase the airflow where necessary but they do not allow it to be lower than the minimum requirement for optimum operation of the heat output.

K.7 Purge ventilation

COMMENTARY ON K.7

Purge ventilation is referenced within Building Regulations guidance and it is intended to introduce rapid ventilation throughout the building to aid removal of high concentrations of pollutants and water vapour released from occasional activities such as painting and decorating or accidental releases such as smoke from burnt food or spillage of water. Purge ventilation is intermittent, i.e. only required when such occasional activities occur.

Purge ventilation provisions can also be used to improve thermal comfort and/or over-heating of buildings in summer, especially the overnight cooling of buildings with high thermal mass as part of an overall cooling strategy. This is considered further in the appropriate Building Regulation guidance on ventilation [19,20,21].

Openable windows normally meet the requirements for purge ventilation. Where there are no openable windows it might be necessary to provide a mechanical fan system which is capable of a the high extract rate defined by regulations.

K.8 Drying rooms/cupboards

Where a heated drying cupboard/room is provided it should be ventilated to disperse moisture directly to the outside. Alternatively, where the drying area is located within another room, e.g. bathroom, the ventilation should be controlled by a humidistat that will respond to increased moisture levels.

Humidistat controllers may be incorporated into some fans or may be mounted separately. Care should be exercised in mounting them in the most appropriate location such that they operate at their peak efficiency and prevent the spread of moisture. The manufacturer's instructions/recommendations should be followed.

K.9 Dehumidifiers

The portability of these units means that they may be used as circumstances demand and moved elsewhere if needed. These products are not recommended for continuous use but may be used to assist in reduction of water content within the air.

COMMENTARY ON K.9

Electric dehumidifiers that work on a closed refrigeration cycle both dry and heat the air. As some latent heat is released when the water that is extracted from the air condenses within the unit, the heat output can be 10% to 30% greater than the electricity consumed. An essential feature of all dehumidifiers is that the volume of water that they extract is dependant on the temperature and vapour pressure of the air. They are more effective in warmer dwellings where condensation problems might be caused by high vapour pressures, than in more typical condensation prone dwellings where the problems are caused by low temperature. These units can be fairly obtrusive and can be noisy to run overnight in bedrooms, they might not therefore be acceptable to all occupiers.

Annex L
(normative)**Application of design principles – Heating****L.1 General**

NOTE Many condensation problems arise because the majority of buildings are not used 24 hours a day for every day of the year and are, therefore, not heated continuously.

In new buildings, the building fabric should be insulated to the optimal level so that any necessary heating can be provided as economically as possible. In existing buildings, the building fabric insulation standards should preferably be upgraded so that any necessary heating can be provided in a cost-effective manner.

To minimize surface condensation the duration and amount of heating should be regulated to maintain the internal surface temperatures above dewpoint; ideally, this involves matching the heating system to the thermal mass of the building fabric and to the way that the heating system is likely to be used by the building occupants.

Ignoring the comfort of the occupants, the aim should be to maintain an air temperature above 10 °C in all parts of the building that are heated.

To achieve a satisfactory balance of internal temperatures, detailed calculations should be made, taking account of solar gains, internal gains, ventilation rates and local climatic conditions as well as the thermal response of the building fabric.

COMMENTARY ON L.1

In well insulated buildings, it is possible to maintain these temperatures without any heating other than that given off by lighting and equipment such as computers.

Surface condensation is unlikely to be a problem in regularly heated buildings with a low vapour load, such as office buildings, and is most commonly found in dwellings that are insufficiently heated and in other buildings that are used, and consequently heated, intermittently, such as churches.

Surface condensation is likely in buildings such as swimming pools and laundries where large amounts of moist air are generated on a regular basis. These types of buildings are beyond the scope of this standard but the design principles of Clause 9 would apply to their design.

Further guidance on heating provision is given in CIBSE Guide B Heating [22] and in CIBSE Domestic heating – design guide [24].

L.2 Warm air heating

Warm air systems should be installed in accordance with BS 5864 and also with due reference to British System Design Manual (Gas fired warm air heating) [25].

A percentage outdoor air make-up as described in BS 5864, Section 3, may be incorporated into a warm air system. This will provide a definite air change for the building, a positive air pressure to moisture producing areas and thus a flow of moisture to outside.

COMMENTARY ON L.2

Wholly convective heat from forced warm air systems, heats room air very rapidly and is liable to be operated intermittently to provide heat only when required for the comfort of the occupants.

Modern forced warm air heating systems are used in a similar fashion to water-based central heating systems, where by use of a time clock the warm air system is used to preheat buildings before occupation, normally with a reduced preheat time when compared to water based systems. Current warm air heaters have electronic controls, which proportionally vary heat output to avoid large temperature swings and maintain preset temperatures. This allows warm air systems to be used in both low thermal mass buildings and high thermal mass buildings.

An advantage of forced warm air heating can be that it creates sufficient air movement to reduce the risk of stagnant air pockets, e.g. in the corners of rooms.

L.3 Hot water radiators

COMMENTARY ON L.3

These produce natural convective heating and as they do not respond as quickly as warm air systems, are more suited to high mass buildings. They are normally heated before building occupation and give off residual heat after the system is switched off thus prolonging the heating period. Hot water radiators are also suitable for low mass buildings but surface temperatures in these types of buildings will fall more rapidly after the heating is switched off as there is little thermal storage in the structure.

L.4 High temperature radiant heaters

COMMENTARY ON L.4

These include radiant gas and electric fires, and produce easily controlled and almost immediately felt local warmth. However, both are unlikely to be used for sufficiently long to warm the structure adequately and they can also leave some parts of a room relatively unheated.

Gas fires need a satisfactory air supply for combustion and this, plus the warm flue, will create some ventilation to the room in which they are sited.

L.5 Low temperature radiant heaters

COMMENTARY ON L.5

These heating elements are normally embedded in the floor. Underfloor heating in a high mass floor gives out heat for long periods, which is advantageous in controlling condensation.

L.6 Electric storage heaters

Electric storage heaters generally have a low rate of heat output; the charging period should be related both to the needs of the occupants and to the need for an adequate reserve for heating the building fabric.

COMMENTARY ON L.6

Storage heaters without fans emit heat almost continually to provide background heating, however they can be difficult to control. Storage heaters with fans have some characteristics similar to forced warm air heating. Some storage heaters incorporate a radiant heating element to provide rapid local warmth when required. Because of their characteristics, storage heaters are particularly suited to buildings that are occupied for long periods, and/or for buildings of high thermal mass.

L.7 Unflued oil and gas heaters

These are normally used as supplementary or temporary heating; their use should be avoided as they release large quantities of water vapour into the room. To avoid the need for such supplementary heating, the building should be designed so that it can be adequately heated in an economical manner.

L.8 Open fires and solid fuel burning stoves*COMMENTARY ON L.8*

These require considerable air supplies for combustion and can result in much heat loss via the flue. The effect of the heated flue will be to draw air from other parts of the building including the moisture generating areas. However, the high air change rate in the room will usually negate any increased risk of condensation in that room that would have resulted from moist air being pulled in.

L.9 Heating controls

Two factors control the output of a heating system: the length of time that the system is operative and the output power of the system: heating systems that are capable of being automated should have time controls to regulate the duration of heat output and temperature controls to ensure that the heating is switched off in rooms or zones (where the heating system is zoned) when the demand temperature is met. Some set-back control to maintain lower-than-comfort temperatures when the building is not in use are particularly beneficial in avoiding large fluctuations in temperatures which would exacerbate the risk of condensation.

Further advice is given in Good Practice Guide 302, *Controls for domestic central heating and hot water — guidance for specifiers and installers* [26].

Annex M
(informative)
M.1

Guidance for builders**General**

The avoidance of damaging condensation in a building is dependent not only upon the correct design decisions but equally upon the correct interpretation of the design by workmen on site and awareness on the part of the building owners/occupiers. Condensation seldom occurs as a result of malevolent actions, rather it results from a lack of understanding arising from a failure to communicate important information in a way that can be easily understood.

Condensation which occurs on an internal surface can be seen and easily removed before it can cause damage, if left it will encourage the growth of mould, which is not only unsightly but also a health hazard. However, condensation which occurs within the fabric of the building envelope is not visible and can cause severe damage, leading to loss of thermal performance and, in extreme cases, structural failure.

Designers should use this Code of Practice when preparing their designs and then tell the builder what aspects of the design are particularly important for the avoidance of condensation, and why they are so important. Those who own, maintain and occupy the building must also be made aware of how it should be used, and what to do and what not to do, in order to avoid unsightly and damaging condensation.

M.2 Construction materials

M.2.1 Dry materials and components

When assessing the risk of condensation occurring in any part of a building, designers will rely upon data in this standard (and on information supplied by manufacturers) to determine the performance characteristics of the materials and components to be used in the construction, particularly their resistance to the passage of heat, air and moisture. Those materials and components are presumed to be dry but if for any reason they are not dry then they will not perform as intended and the construction may fail. This is especially important in the case of insulation materials and components (such as bricks, blocks, timber and timber-based products) which absorb water. If the building is to perform as intended, the materials and components of which it is built must be received, stored and installed dry.

M.2.2 Products made with water

Some products, notably cement, lime and plaster, must be mixed with water in order to produce concrete, mortar for brickwork and blockwork, render and plaster all of which are placed wet; excess water must then dry out from those products by evaporation which can take a long time, especially during winter or when the product is covered by subsequent impervious layers such as asphalt on a roof slab or PVC tiles on a floor slab. During the drying out period it is very important to ensure that excess water is removed from the building by natural or forced ventilation or by the use of dehumidifiers.

M.2.3 Vapour control and airtightness

The warm air inside a heated building will contain a lot of moisture in the form of water vapour which will condense if it comes into contact with a cold surface anywhere in the construction. To prevent that happening, recently constructed buildings incorporate impermeable barriers to limit the movement of water vapour and prevent it forming condensation within the construction. Whilst atmospheric moisture can diffuse slowly through absorbent materials such as masonry and plaster, much greater quantities will be carried by air leaking through any holes, cracks or gaps in the building fabric. It is therefore extremely important that all constructions be as air-tight as possible.

Where an AVCL is called for it should be carefully installed to ensure complete air-tightness: all laps and joints, and any necessary penetrations by pipes or cables, should be sealed and carefully inspected before being covered.

AVCLs should always be placed on the warm side of the thermal insulation.

M.2.4 Thermal insulation

Thermal insulants should be installed in a continuous layer without gaps or interruptions as these will form thermal bridges which can result in localised internal surface condensation. All insulants should be closely butted together and, if placed between framing members, should be carefully cut and wedged in place to minimise air movement.

If different types of insulant are used in successive layers, the layer with the greater vapour resistance should always be placed closer to the heated interior.

Where two layers of the same type of insulation are used, the thinner one should be on the inside.

M.2.5 Vents

Where the design calls for ventilation to be provided (for example in a cold pitched roof) it is very important to ensure that all vents and air movement paths be keep free of obstruction; this is especially important in the case of small openings which are at risk of becoming blocked or covered over during the course of construction.

Annex N
(informative)

Guidance for occupiers on how to avoid damaging condensation

N.1 General

Anyone responsible for the care and maintenance of a heated building should be aware that condensation can cause severe damage to the fabric of the building and might also pose a health hazard for the occupants.

Designers and builders can follow the principles and guidance contained in this British Standard in order to minimize the risk of damaging condensation; the purpose of this annex is to provide building users, particularly homeowners, with non-technical guidance on the application of those same principles in practice.

N.2 Basic principles

All air contains some degree of moisture, in the form of invisible water vapour. The warmer the air the more moisture it can support. When warm moist air is cooled, or comes into contact with a cold surface, the water it contains is deposited as condensation; if that happens on an exposed surface, such as a window pane, where it is easy to see, it should be wiped up immediately or it will encourage the growth of mould, which is not only unsightly but can also be a health hazard and lead to respiratory problems.

Condensation can also occur out of sight within the fabric of floors, walls and roofs where it is termed "interstitial". That is most likely to happen as a result of air-borne moisture leaking out through cracks, gaps and holes in the building fabric and is potentially much more damaging. Interstitial condensation will reduce the value of any thermal insulant contained within the building fabric—thereby increasing heat loss from the building, and is likely to cause wood to rot and metal to rust.

N.3 How to avoid damaging condensation

The first and most important step is to avoid generating moisture within the building as far as possible and to limit the spread of warm moist air from one room to another. Any activity involving the use of water in a heated building has the potential to increase the risk of condensation as warmed air absorbs moisture from any source, be it industrial process, bathing, cooking, growing house-plants or washing clothes. The spread of warm moist air from areas such as bathrooms, kitchens, toilets and laundries can be limited by keeping doors closed and by opening windows or using extract fans to remove excess moisture as close to source as possible.

Laundry should never be hung to dry in unheated or unventilated rooms; if outdoor drying is not available laundry should be dried in a well ventilated room or in a ventilated drying cabinet or in a condensing tumble dryer [or one which is vented direct to the outside].

The most efficient and cost-effective way to remove excess moisture is by natural ventilation. This relies upon the buoyancy of warm internal air and the provision of carefully sited vents which encourage a steady flow of air through the building. Alternatively, excess moisture may be removed and condensation minimized by mechanical extraction, such as using an electrical fan controlled by a humidistat.

Having first reduced the amount of moisture in the air as much as possible, energy used to heat the building during cold weather is best applied to heat all internal spaces throughout the day. The risk of condensation is reduced by maintaining a steady, even temperature rather than allowing wide temperature variations in different rooms and/or at different times.

Heating by means of flueless room heaters which use paraffin or bottled gas are not recommended as they greatly increase the amount of moisture in the air. Furniture, especially large items such as wardrobes, should not be placed hard against an external wall, and air should be able to circulate around all furniture.

NOTE If some rooms are unheated then water vapour which moves from other rooms can accumulate to the point where it will cause condensation.

N.4 Dehumidification

A new building can contain excess moisture as a result of it being inadequately protected during construction whilst dampness in existing buildings can occur as a consequence of flooding or a leaking roof or burst pipes. In such cases a suitably sized dehumidifier can be used to good effect to remove the excess moisture rapidly and so reduce the risk of further damage due to condensation; additional heating and ventilation is also likely to be required, particularly during cold weather.

N.5 Alterations and extensions

Before embarking upon alterations or extensions to an existing building it is important to understand what provisions were made in the original construction to avoid damaging condensation. These might, for example, consist of an airtight ceiling, or vents to allow a flow of outside air through the loft, or the inclusion of vapour control layers, air leakage barriers and seals around pipes and cables where they go through a wall. It is then important to carry through the same design and construction principles when making the alterations or extensions so as to avoid causing unintended damage to the system of condensation control.

Seemingly minor alterations, such as the insertion of down-lighter fittings in a ceiling, can have very serious consequences. If such fittings are installed below a roof space, then sealed fittings have to be used in order to maintain the integrity of the ceiling as an air-leakage barrier.

N.6 Care and maintenance

Building owners, landlords, managing agents and tenants should all be aware of the measures required to ensure the building continues to function as intended. To that end, every building should be provided with an operating manual which sets out the procedures which need to be followed and states who is to be responsible for each one, much like the owner's manual provided with a new car.

Bibliography

Standards references

For dated references, only the edition cited applies. For undated references, the latest edition of the referenced document (including any amendments) applies.

BS 2972, *Methods of test for inorganic thermal insulating materials*

BS 6576, *Code of practice for diagnosis of rising damp in walls of buildings and installation of chemical damp-proof courses*

BS 8102, *Code of practice for protection of below ground structures against water from the ground*

BS 8103-1, *Structural design of low rise buildings – Code of practice for stability, site investigation, foundations and ground floor slabs for housing*

BS 8103-2, *Structural design of low rise buildings – Code of practice for masonry walls for housing*

BS 8103-3, *Structural design of low rise buildings – Code of practice for timber floors and roofs for housing*

BS 8103-4, *Structural design of low rise buildings – Code of practice for suspended concrete floors for housing*

BS 8204 (all parts), *Screeds, bases and in situ flooring*

BS EN 13141-1, *Ventilation for buildings – Performance testing of components/products for residential ventilation – Part 1: Externally and internally mounted air transfer devices*

BS EN 13141-2, *Ventilation for buildings – Performance testing of components/products for residential ventilation – Part 2: Exhaust and supply air terminal devices*

BS EN 13141-3, *Ventilation for buildings – Performance testing of components/products for residential ventilation – Part 3: Range hoods for residential use*

BS EN 13141-4, *Ventilation for buildings – Performance testing of components/products for residential ventilation – Part 4: Fans used in residential ventilation systems*

BS EN 13141-6, *Ventilation for buildings – Performance testing of components/products for residential ventilation – Part 6: Exhaust ventilation system packages used in a single dwelling*

BS EN 13141-7, *Ventilation for buildings – Performance testing of components/products for residential ventilation – Part 7: Performance testing of a mechanical supply and exhaust ventilation units (including heat recovery) for mechanical ventilation systems intended for single family dwellings*

BS EN 13141-8, *Ventilation for buildings – Performance testing of components/products for residential ventilation – Part 8: Performance testing of un-ducted mechanical supply and exhaust ventilation units (including heat recovery) for mechanical ventilation systems intended for a single room*

BS EN 13141-9, *Ventilation for buildings – Performance testing of components/products for residential ventilation – Part 9: Externally mounted humidity controlled air transfer device*

BS EN 13141-10, *Ventilation for buildings – Performance testing of components/products for residential ventilation – Part 10: Humidity controlled extract air transfer devices*

BS EN 12524, *Building materials and products – Hygrothermal properties – Tabulated design values*

BS EN 13859-2, *Flexible sheets for waterproofing. Definitions and characteristics of underlays – Part 2: Underlays for walls*

BS EN 15026, *Hygrothermal performance of building components and building elements – Assessment of moisture transfer by numerical simulation*

BS EN ISO 12572, *Hygrothermal performance of building materials and products – Determination of water vapour transmission properties*

BS EN ISO 13370, *Thermal performance of buildings – Heat transfer via the ground. Calculation methods*

PD 6697, *Recommendations for the design of masonry structures to BS EN 1996-1-1 and BS EN 1996-2*

Other publications

- [1] DETR. *English House Condition*, 1996 Energy Report, 2000.
- [2] BRE Digest 245. *Rising damp in walls: diagnosis and treatment*. Garston: BRE.
- [3] BRE Report 466. *Understanding dampness – effect, diagnosis and remedies*. Garston: BRE.
- [4] BRE Digest 139. *Controlling moulds and lichens*. Garston: BRE.
- [5] BRE IP 5/06. *Modelling condensation and airflow in pitched roofs*. Garston: BRE. April 2006.
- [6] CIBSE Guide A3. *Thermal properties of building structures*. Available from the Chartered Institution of Building Services Engineers, Delta House, 222 Balham High Road, London SW12 9BS.
- [7] MCRMA & EPIC Technical Paper 17. *Design Guide for metal roofing and cladding*. (TP 17). www.mcrma.co.uk
- [8] MCRMA Technical Paper No. 18. *Conventions for calculating U-values, f-values and Psi values* (TP 18). www.mcrma.co.uk.
- [9] BRE IP 1/06. *Assessing the effect of thermal bridging at junctions and around openings*. Garston: BRE. March 2006.
- [10] BRE BR 497. *Conventions for calculating linear thermal transmittance and temperature factors*. Garston: BRE.
- [11] Good Practice Guide 174, *Limiting thermal bridging in new dwellings*. London: TSO.
- [12] Good Practice Guide 183, *Limiting thermal bridging in existing dwellings*. London: TSO.
- [13] DEFRA/DTLR Report: *Limiting thermal bridging and air leakage: Robust construction details for dwellings and similar buildings*. London: TSO. October 2001.
- [14] Accredited Construction Details for Part L. Available online at www.planningportal.gov.uk.
- [15] Accredited Construction Details (Scotland). Available online at www.scotland.gov.uk.
- [16] Energy Saving Trust. CE302 – *Enhanced Construction Details: thermal bridging*. Available online at www.energysavingtrust.org.uk.
- [17] MCRMA. Technical Paper 18. *Conventions for Calculating U-Values*
- [18] Energy Saving Trust. GPG 268 – *Energy efficient ventilation in dwellings – a guide for specifiers*. 2006.

- [19] Approved Document F Ventilation. Applicable in England and Wales. Available online at www.planningportal.gov.uk.
- [20] Technical Handbooks. Applicable in Scotland. Available online from Scottish Building Standards at <http://www.sbsa.gov.uk>.
- [21] Technical Booklet K Ventilation. Applicable in Northern Ireland. Available online at www.buildingregulationsni.gov.uk.
- [22] CIBSE Guide B. *Heating, Ventilating, Air Conditioning and Refrigeration*. Available from the Chartered Institution of Building Services Engineers, Delta House, 222 Balham High Road, London SW12 9BS.
- [23] BRE IP 13/94. *Passive stack ventilation systems: design and installation*. Garston: BRE. July 1994.
- [24] CIBSE, *Domestic heating – Design guide*. Available from the Chartered Institution of Building Services Engineers, Delta House, 222 Balham High Road, London SW12 9BS.
- [25] *British System Design Manual (Gas fired warm air heating)*. 1988. Available from Benn Publications Limited, Sovereign Way, Tonbridge, Kent TN5 1RW.
- [26] Good Practice Guide 302, *Controls for domestic central heating and hot water – guidance for specifiers and installers*. London: TSO.

Further reading

BRE Digest 296. *Timbers: their natural durability and resistance to preservative treatment*. Garston: BRE.

CIBSE Guide J. *Weather, solar and illuminance data*. Available from the Chartered Institution of Building Services Engineers, Delta House, 222 Balham High Road, London SW12 9BS.

BRE Digest 398. *Continuous mechanical ventilation in dwellings: design, installation and operation*. Garston: BRE.

BRE Report 262. *Thermal insulation: avoiding risks*. Garston: BRE.

British Standards Institution (BSI)

BSI is the independent national body responsible for preparing British Standards and other standards-related publications, information and services.

It presents the UK view on standards in Europe and at the international level.

It is incorporated by Royal Charter.

Revisions

British Standards are updated by amendment or revision. Users of British Standards should make sure that they possess the latest amendments or editions.

It is the constant aim of BSI to improve the quality of our products and services. We would be grateful if anyone finding an inaccuracy or ambiguity while using this British Standard would inform the Secretary of the technical committee responsible, the identity of which can be found on the inside front cover.

Tel: +44 (0)20 8996 9001 Fax: +44 (0)20 8996 7001

BSI offers Members an individual updating service called PLUS which ensures that subscribers automatically receive the latest editions of standards.

Tel: +44 (0)20 8996 7669 Fax: +44 (0)20 8996 7001

Email: plus@bsigroup.com

Buying standards

You may buy PDF and hard copy versions of standards directly using a credit card from the BSI Shop on the website www.bsigroup.com/shop. In addition all orders for BSI, international and foreign standards publications can be addressed to BSI Customer Services.

Tel: +44 (0)20 8996 9001 Fax: +44 (0)20 8996 7001

Email: orders@bsigroup.com

In response to orders for international standards, it is BSI policy to supply the BSI implementation of those that have been published as British Standards, unless otherwise requested.

Information on standards

BSI provides a wide range of information on national, European and international standards through its Knowledge Centre.

Tel: +44 (0)20 8996 7004 Fax: +44 (0)20 8996 7005

Email: knowledgecentre@bsigroup.com

Various BSI electronic information services are also available which give details on all its products and services.

Tel: +44 (0)20 8996 7111 Fax: +44 (0)20 8996 7048

Email: info@bsigroup.com

BSI Subscribing Members are kept up to date with standards developments and receive substantial discounts on the purchase price of standards. For details of these and other benefits contact Membership Administration.

Tel: +44 (0)20 8996 7002 Fax: +44 (0)20 8996 7001

Email: membership@bsigroup.com

Information regarding online access to British Standards via British Standards Online can be found at www.bsigroup.com/BSOL

Further information about BSI is available on the BSI website at www.bsigroup.com/standards

Copyright

Copyright subsists in all BSI publications. BSI also holds the copyright, in the UK, of the publications of the international standardization bodies. Except as permitted under the Copyright, Designs and Patents Act 1988 no extract may be reproduced, stored in a retrieval system or transmitted in any form or by any means – electronic, photocopying, recording or otherwise – without prior written permission from BSI. This does not preclude the free use, in the course of implementing the standard of necessary details such as symbols, and size, type or grade designations. If these details are to be used for any other purpose than implementation then the prior written permission of BSI must be obtained. Details and advice can be obtained from the Copyright & Licensing Manager.

Tel: +44 (0)20 8996 7070

Email: copyright@bsigroup.com

BSI Group Headquarters

389 Chiswick High Road London W4 4AL UK

Tel +44 (0)20 8996 9001

Fax +44 (0)20 8996 7001

www.bsigroup.com/standards

raising standards worldwide[™]

